

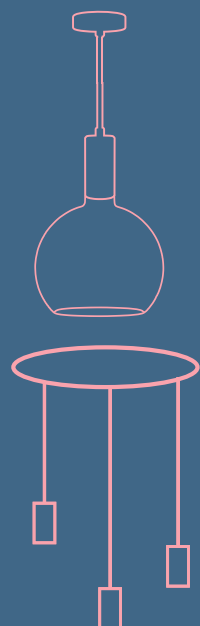

SEGULA



PERLUCCI



AMARCÒRDS

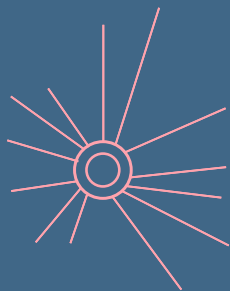

 Art Maker



think paper

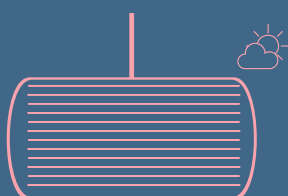

BLOS™



LIGHT
TECHNOLOGY
NEDERLAND

Light Technology
Nederland B.V.

Bezoek-/postadres:
Kerkstraat 83
5126 GB Gilze

Magazijn:
Ericssonstraat 2 (1044 F)
5121 ML Rijen

+31 (0)13 590 01 30
info@light-technology.nl
www.light-technology.nl

BTW NL805480699B01
KVK 18046723
IBAN NL29ABNA0578449935



PAGE: 6 - 72

SEGULA

SEGULA is een Duits merk van LED lichtbronnen dat al 15 jaar staat voor uitmuntende kwaliteit en gepatenteerde innovatie. Bent u op zoek naar een betrouwbare standaard retrofit lamp of naar een waanzinnige EYE-catcher...bij SEGULA vindt u ongetwijfeld wat u nodig heeft.

SEGULA est une marque allemande de sources lumineuses LED qui, depuis 15 ans, est synonyme d'excellence en termes de qualité et d'innovation brevetée. Que vous soyez à la recherche d'une ampoule standard fiable ou d'une pièce qui attire le regard... chez SEGULA, vous êtes sûr de trouver ce qu'il vous faut.

SEGULA is a German brand of LED lightbulbs that stands for excellence in quality and patented innovation for over 15 years. Are you looking for a reliable standard retrofit bulb or an extraordinary EYE catcher...with SEGULA, you are sure to find what you need.



PAGE: 73 - 89

PERLUCI

Het huismerk van Quality LEDs biedt u de mogelijkheid om uw verlichtingsproject te personaliseren. Onze in België gemaakte plafondplaten zorgen ervoor dat uw projecten net dat tikkeltje meer krijgen!

La marque propre de Quality LEDs vous offre la possibilité de personnaliser votre projet d'éclairage. Fabriquées en Belgique, nos bases de plafond donneront à vos projets le petit plus qui fait la différence !

Quality LEDs' own brand offers you the opportunity to personalize your lighting project. Made in Belgium, our ceiling plates will give your projects just that extra touch!



PAGE: 90 - 100

AMARCORDS

Een Italiaanse fabrikant met productie van hoogwaardige designverlichting in Milaan. Amarcords is misschien niet het grootste bedrijf in omvang, maar blinkt uit in kwaliteit, afwerking en originaliteit. De vele kleurencombinaties van het Mono-fase railsysteem zorgen voor zeer eigentijdse creaties en heel veel mogelijkheden.

Fabricant italien produisant des luminaires design de haute qualité à Milan. Amarcords n'est peut-être pas la plus grande société, mais elle excelle en termes de qualité, d'exécution et d'originalité. Les nombreuses combinaisons de couleurs du système de rails Monophasé permettent des créations très contemporaines et offrent beaucoup de possibilités.

An Italian manufacturer with production of high-quality design lighting in Milan. Amarcords may not be the biggest company in size but it excels in quality, craftsmanship and originality. The numerous colour combinations of the Monophase track system provide very contemporary creations and lots of possibilities.



PAGE: 101 - 106

Art Maker

Deze Belgische ontwerper met eigen productie in de Belgische Ardennen is echt het ontdekken waard. Niet alleen worden deze volledig houten pareltjes gemaakt zonder lijm of schroeven, ze vullen ruimtes en doen monden openvallen. Om het helemaal duurzaam en ecologisch te maken wordt er voor elk geproduceerd armatuur een boom gepland, kan het nog beter?

Ce designer belge dont la production est située dans les Ardennes, mérite vraiment d'être découvert. Non seulement ces bijoux en bois sont fabriqués sans colle ni vis, mais ils remplissent les espaces et ne vous laissent pas indifférents... Pour que ce soit totalement durable et écologique, un arbre est planté pour chaque luminaire produit, peut-on faire mieux ?

This Belgian designer with its own production in the Belgian Ardennes is really worth discovering. Not only are these all-wood jewels made without glue or any screws, they fill spaces and make mouths drop open. To make it completely sustainable and ecological, a tree is planted for each luminaire produced, can it get any better?



PAGE: 107 - 122

think paper

Handgemaakte lampen gemaakt uit gerecycleerd papier. Deze in Nederland ontworpen en geproduceerde lampen zijn tijdloos en maken van elke ruimte iets magisch. Bovenop het milieu doe je vooral jezelf een plezier als je kiest voor één van deze mooie duurzame lampen.

Des suspensions réalisées à la main en carton recyclé. Conçues et produites aux Pays-Bas, ces lampes intemporelles transforment votre intérieur en quelque chose de magique. En plus d'être éco-responsable, ces luminaires vous donneront entière satisfaction.

Handmade pendant lamps made from recycled paper. Designed and produced in the Netherlands, these timeless lampshades turn any space into something magical. On top of the environment, you are mostly doing yourself a favour when you choose one of these beautiful sustainable lamps.



PAGE: 123 - 126

BLOS™

Nu eindelijk ook mooie hanglampen voor buiten. Dankzij de Nederlandse ontwerpstudio BLOS kunt u nu ook genieten van duurzame, handgemaakte buitenverlichting. Ze gaan van klein tot HEEL groot...voor een buitenproject met een IBIZA gevoel zit je bij BLOS helemaal goed!

Voici enfin de belles lampes suspendues pour l'extérieur. Grâce au studio de design néerlandais BLOS, vous pouvez désormais profiter d'un éclairage extérieur durable et fabriqué de façon artisanale. La gamme s'étend du petit au TRES grand modèle... pour un projet d'extérieur avec une touche d'IBIZA... BLOS est le choix à faire !

Now finally beautiful pendant lights for outdoor use. Thanks to Dutch design studio BLOS, you can now enjoy sustainable, handmade outdoor lighting. They range from small to HUGE...for an outdoor project with an IBIZA vibe, BLOS is the perfect choice!



SEGULA

ONZE VISIE

Sinds meer dan 15 jaar staat het merk SEGULA voor innovatie, hoge kwaliteit en een tijdloos design. Deze principes zijn steeds bepalend geweest voor de samenstelling van ons gamma en dit sinds het prille begin.

Voor de meeste mensen is het licht van een klassieke gloeilamp nog steeds het mooiste en aangenaamste licht. Door zijn uniforme spectrum, zijn warme lichtkleur

NOTRE VISION

Depuis plus de 15 ans, la marque SEGULA est synonyme d'innovation, de haute qualité et de design intemporel. Ces principes ont toujours déterminé la composition de notre gamme et ce, depuis le début.

Pour la majorité des personnes, la lumière d'une lampe à incandescence classique reste la plus belle et la plus agréable. En raison de son spectre uniforme, de sa couleur chaude et de son bon rendu des

OUR VISION

For more than 15 years, the brand SEGULA has stood for innovation, high quality and timeless design. These principles have always been decisive for the composition of our range from the very beginning.

For most people, the light from the classic light bulb is still the most beautiful and pleasant light.

Due to its uniform spectrum, its warm light colour and its good colour rendering, this

en zijn mooie kleurweergave leunt dit licht namelijk zeer dicht aan bij natuurlijk zonlicht. Met onze SEGULA lampen brengen we dit aangename, warme licht van gloeilampen terug! Ze bieden namelijk een uitstekende kleurweergave, een excellente kwaliteit en mooie decoratieve looks terwijl ze gebruik maken van de energiezuinige en duurzame LED-technologie. Het economische gebruik van grondstoffen en het vermijden van giftige stoffen dragen bij tot een hoge recycleerbaarheid van deze lampen. Vervang dus al uw gloeilampen, halogeenlampen en spaarlampen

couleurs, cette lumière est très similaire à la lumière naturelle du soleil. Avec nos lampes SEGULA, nous faisons revivre la lumière agréable et chaleureuse des lampes à incandescence !

Elles offrent un excellent rendu des couleurs, une qualité exceptionnelle et un bel aspect décoratif tout en utilisant une technologie LED économe en énergie et durable. L'utilisation économique des matières premières et l'absence de substances toxiques contribuent au bon recyclage de ces lampes. Remplacez donc toutes vos lampes à incandescence, halogènes et éco-

light comes very close to natural sunlight. With our SEGULA lamps we bring back this pleasant, warm light of light bulbs! They offer excellent colour rendition, an excellent quality and beautiful decorative looks while using energy-efficient and durable LED technology.

The economical use of raw materials and the avoidance of toxic substances contribute to the high recyclability of these bulbs. So replace all your incandescent halogen bulbs and energy-saving bulbs with high-quality, efficient and ecological bulbs from SEGULA.

door de kwalitatieve, efficiënte en ecologische lampen van SEGULA. Op deze manier dragen we samen ons steentje bij aan een gezondere omgeving.

nomiques par des lampes de haute qualité, efficaces et écologiques de SEGULA. De cette façon, nous contribuons tous à un environnement plus sain.

In this way together we can contribute to a healthier environment.

NEW



like YING & YANG –
contradictory and yet harmonious
in balance

FLOATING Line

Glossy | E27



NEW

SG-55582
LED Floating Glossy Globe 200
black
4,5 W | 300 lm | 2200 K



NEW

SG-55581
LED Floating Glossy Globe 150
black
4 W | 240 lm | 2200 K



NEW

SG-55580
LED Floating Glossy Globe 125
black
4 W | 240 lm | 2200 K



NEW

SG-55572
LED Floating Glossy Globe 200
white
4,5 W | 300 lm | 2200 K



NEW

SG-55571
LED Floating Glossy Globe 150
white
4 W | 240 lm | 2200 K



NEW

SG-55570
LED Floating Glossy Globe 125
white
4 W | 240 lm | 2200 K

Art.No	dim	Base	Watt	^Watt	Lumen	Kelvin	CRI	EEK	Ø	H	Pck
SG-55580	✓	E27	4	24	240	2200	90	G	125	165	8 / 24
SG-55581	✓	E27	4	24	240	2200	90	G	150	185	6 / 24
SG-55582	✓	E27	4,5	28	300	2200	90	G	200	230	6 / 12
SG-55570	✓	E27	4	24	240	2200	90	G	125	165	8 / 24
SG-55571	✓	E27	4	24	240	2200	90	G	150	185	6 / 24
SG-55572	✓	E27	4,5	28	300	2200	90	G	200	230	6 / 12



New Forms – Oval | Ufo

Let yourself be carried away into the world of style by our **FLOATING Line** novelties. The journey of floating light continues – the same warm light, but in completely new shapes. Even when switched off, these **FLOATINGS** are a real eye-catcher. You can't get enough of such **UFO** sightings

FLOATING Line

45° | 90° | Oval | Ufo | E27



SG-55028
LED Floating Oval 200
golden
4,5 W | 300 lm | 2200 K



SG-55037
LED Floating Ufo 220
golden
4 W | 240 lm | 2200 K



SG-55031
LED Floating Globe 150
golden 45°
4,5 W | 300 lm | 2200 K



SG-55033
LED Floating Globe 150
golden 90°
4,5 W | 300 lm | 2200 K

Art.No	dim	Base	Watt	^Watt	Lumen	Kelvin	CRI	EEK	Ø	H	Pck
SG-55028	✓	E27	4,5	28	300	2200	90	G	200	190	6 / 12
SG-55037	✓	E27	4	24	240	2200	90	G	220	120	6 / 12
SG-55031	✓	E27	4,5	28	300	2200	90	G	150	200	6 / 24
SG-55033	✓	E27	4,5	28	300	2200	90	G	150	200	6 / 24



SG-55004

LED Floating Globe 125 inside
clear

4,5 W | 300 lm | 2200 K



SG-55001

LED Floating Cube
clear

4,5 W | 300 lm | 2200 K



SG-55453

LED Floating Cylinder
fade frost

4,5 W | 300 lm | 2200 K

FLOATING Line

Cylinder | Cube | Globe | clear | 27



SG-55005
LED Floating Globe 80
clear
4 W | 240 lm | 2200 K



SG-55006
LED Floating Globe 125
clear
4,5 W | 300 lm | 2200 K



SG-55007
LED Floating Globe 150
clear
4,5 W | 300 lm | 2200 K



SG-55008
LED Floating Globe 200
clear
5 W | 350 lm | 2200 K



SG-55012
LED Floating Bowl
clear
6,2 W | 460 lm | 2000 - 2700 K



Art.No	dim	Base	Watt	^Watt	Lumen	Kelvin	CRI	EEK	Ø	H	Pck
SG-55001	✓	E27	4,5	28	300	2200	90	G	125	125	20 / 40
SG-55004	✓	E27	4,5	28	300	2200	90	G	125	115	8 / 24
SG-55005	✓	E27	4	24	240	2200	90	G	80	105	20 / 40
SG-55006	✓	E27	4,5	28	300	2200	90	G	125	165	8 / 24
SG-55007	✓	E27	4,5	28	300	2200	90	G	150	185	6 / 24
SG-55008	✓	E27	5	32	350	2200	90	G	200	230	6 / 12
SG-55012	✓ ambient	E27	6,2	39	460	2000 - 2700	90	G	200	150	6 / 12
SG-55453	✓	E27	4,5	28	300	2200	90	G	90	215	6 / 12

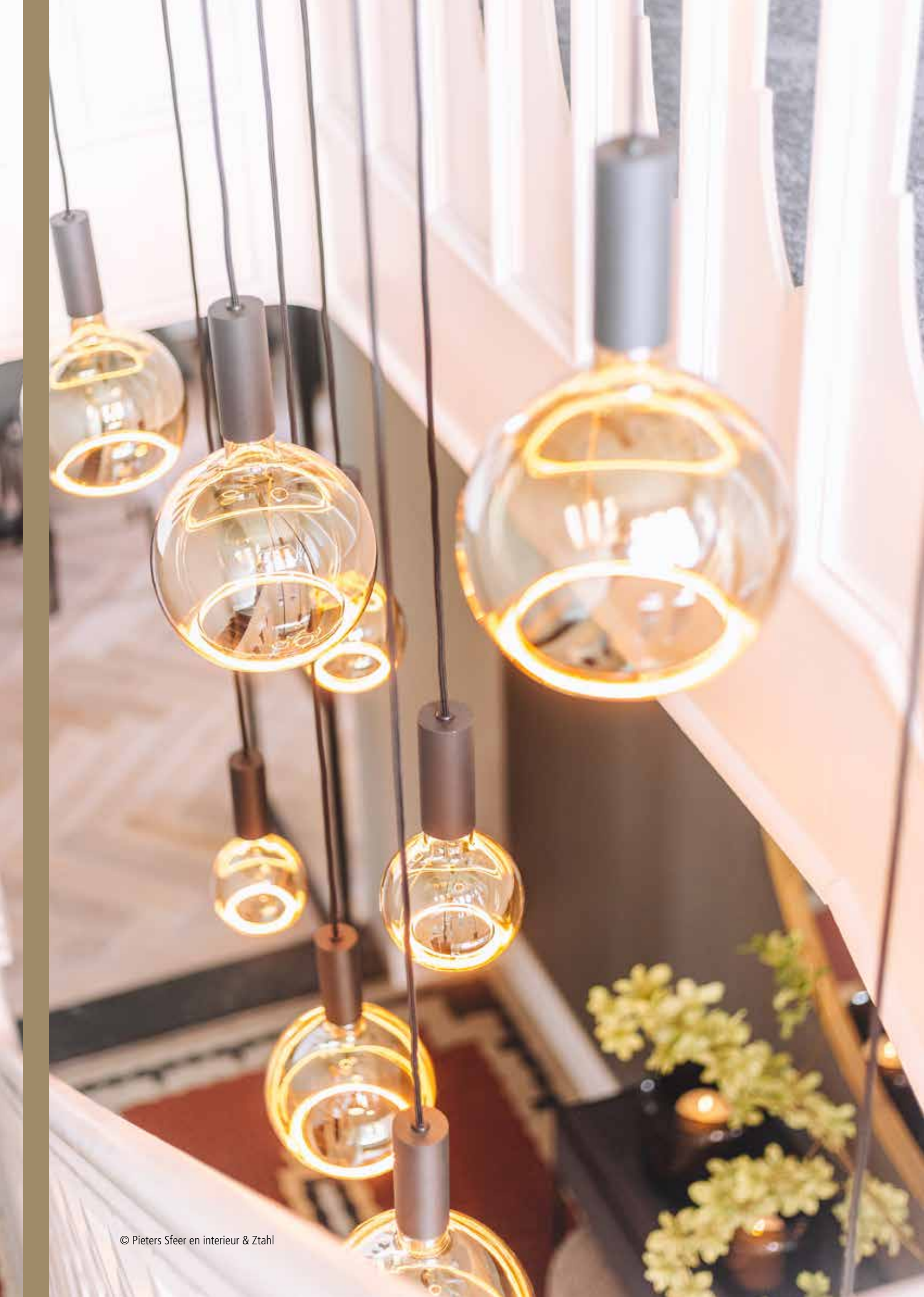

FLOATING Line

gold | E27



SG-55076
LED Floating Globe 125
golden
4 W | 240 lm | 2200 K



SG-55077
LED Floating Globe 150
golden
4 W | 240 lm | 2200 K



SG-55078
LED Floating Globe 200
golden
4,5 W | 300 lm | 2200 K



SG-55079
LED Floating Globe 300
golden
5 W | 350 lm | 2200 K

Art.No	dim	Base	Watt	^Watt	Lumen	Kelvin	CRI	EEK	Ø	H	Pck
SG-55076	✓	E27	4	24	240	2200	90	G	125	165	8 / 24
SG-55077	✓	E27	4	24	240	2200	90	G	150	185	6 / 24
SG-55078	✓	E27	4,5	28	300	2200	90	G	200	230	6 / 12
SG-55079	✓	E27	5	32	350	2200	90	G	300	320	6 / 12



SG-55030
LED Floating Globe 150
smokey grey 45°
6 W | 260 lm | 1900 K



SG-55032
LED Floating Globe 150
smokey grey 90°
6 W | 260 lm | 1900 K



SG-55454
LED Floating Cylinder
smokey frost
4,5 W | 300 lm | 1900 K



SG-55044
LED Floating Reflector 200
smokey grey
6 W | 300 lm | 1900 K

FLOATING Line

45° | 90° | Cylinder | Globe | Reflector | E27
smokey grey



SG-55056
LED Floating Globe 125
smokey grey
6 W | 220 lm | 1900 K



SG-55057
LED Floating Globe 150
smokey grey
6 W | 260 lm | 1900 K



SG-55058
LED Floating Globe 200
smokey grey
6 W | 300 lm | 1900 K



SG-55060
LED Floating Globe 300
smokey grey
8 W | 350 lm | 1900 K

Art.No	dim	Base	Watt	^Watt	Lumen	Kelvin	CRI	EEK	Ø	H	Pck
SG-55030	✓	E27	6	-	260	1900	90	G	150	200	6 / 24
SG-55032	✓	E27	6	-	260	1900	90	G	150	200	6 / 24
SG-55044	✓	E27	6	-	300	1900	90	G	200	115	6 / 12
SG-55454	✓	E27	4,5	-	300	1900	90	G	90	210	6 / 12
SG-55056	✓	E27	6	-	220	1900	90	G	125	165	8 / 24
SG-55057	✓	E27	6	-	260	1900	90	G	150	185	6 / 24
SG-55058	✓	E27	6	-	300	1900	90	G	200	230	6 / 12
SG-55060	✓	E27	8	-	350	1900	90	G	300	320	6 / 12



SG-55073

LED Floating Globe 80
straight golden

4 W | 240 lm | 2200 K



SG-55070

LED Floating Globe 125
twisted smokey grey

6 W | 250 lm | 1900 K



SG-55010

LED Floating Diamond
golden

8 W | 370 lm | 1900 K



FLOATING Line

Diamond | straight & twisted | E27



SG-55074
LED Floating Globe 125
straight golden
4 W | 240 lm | 2200 K



SG-55075
LED Floating Globe 150
straight golden
4 W | 240 lm | 2200 K



SG-55059
LED Floating Globe 150
twisted smokey grey
6 W | 230 lm | 1900 K



SG-55071
LED Floating Globe 200
twisted smokey grey
6 W | 250 lm | 1900 K

Art.No	dim	Base	Watt	^Watt	Lumen	Kelvin	CRI	EEK	Ø	H	Pck
SG-55059	✓	E27	6	23	230	1900	>85	×	150	185	6 / 24
SG-55070	✓	E27	6	25	250	1900	>85	×	125	165	8 / 24
SG-55010	✓	E27	8	33	370	1900	90	×	200	170	8 / 24
SG-55071	✓	E27	6	25	250	1900	>85	×	200	230	6 / 12
SG-55073	✓	E27	4	24	240	2200	90	G	80	105	20 / 40
SG-55074	✓	E27	4	24	240	2200	90	G	125	165	8 / 24
SG-55075	✓	E27	4	24	240	2200	90	G	150	185	6 / 24



FLOATING Line

Outdoor Globe | gold | smokey grey

SG-55024 IP65
LED Floating Globe 125
smokey grey
4 W / 240 lm / 1900 K



SG-55020 IP65
LED Floating Globe 125
golden
4 W / 240 lm / 2200 K



SG-55025 IP65
LED Floating Globe 200
smokey grey
4,5 W / 300 lm / 1900 K



SG-55022 IP65
LED Floating Globe 200
golden
4,5 W / 300 lm / 2200 K



Art.No.	dim	Base	Watt	^Watt	Lumen	Kelvin	CRI	EEK	Ø	H	Pck
SG-55020	yes	E27	4	24	240	2200	CRI 90	G	125	165	8/24
SG-55022	yes	E27	4,5	28	300	2200	CRI 90	G	200	230	6/12
SG-55024	yes	E27	4	24	240	1900	CRI >85	-	125	165	8/24
SG-55025	yes	E27	4,5	28	300	1900	CRI >85	-	200	230	6/12

NEW

← the taste of SEGULA

Another highlight from our Floating Line. Our patented soft filament, which creates filigree reflections, is combined here with extravagant drinking glass shapes. Not only as a creative lighting highlight in hospitality, but also in the home bar or at family celebrations, these lamps create a particularly tasteful atmosphere.

FLOATING Line

Wine | Cocktail | E27



NEW

SG-55465
LED Floating Red Wine
black-smokey grey
5 W / 500 lm / 2200 K



NEW

SG-55464
LED Floating Red Wine
black-clear
5 W / 500 lm / 2200 K



NEW

SG-55463
LED Floating Red Wine
clear-clear
5 W / 500 lm / 2200 K



NEW

SG-55461
LED Floating
Champagne
clear
4 W / 400 lm / 2200 K



NEW

SG-55460
LED Floating
Martini
clear
6 W / 600 lm / 2200 K



NEW

SG-55469
LED Floating
Cognac
clear
6 W / 600 lm / 2200 K

Art.No	dim	Base	Watt	^Watt	Lumen	Kelvin	CRI	EEK	Ø	H	Pck
SG-55465	✓	E27	5	40	500	2200	90	G	120	370	6 / 12
SG-55464	✓	E27	5	40	500	2200	90	G	120	370	6 / 12
SG-55463	✓	E27	5	40	500	2200	90	G	120	370	6 / 12
SG-55461	✓	E27	4	36	400	2200	90	G	80	350	6 / 12
SG-55460	✓	E27	6	40	600	2200	90	G	120	250	6 / 12
SG-55469	✓	E27	6	40	600	2200	90	G	180	290	8 / 16

NEW



ILLUSION Line

Globe | E27
smokey grey



NEW

SG-55479

LED Illusion Globe 125
crescent slanting smokey
6 W / 310 lm / 1900 K



NEW

SG-55480

LED Illusion Globe 125
two crescent smokey
8 W / 400 lm / 1900 K



NEW

SG-55481

LED Illusion Globe 125
crescent top smokey
6 W / 320 lm / 1900 K

Art.No	dim	Base	Watt	^Watt	Lumen	Kelvin	CRI	EEK	Ø	H	Pck
SG-55479	✓	E27	6	29	310	1900	90	×	125	180	8 / 24
SG-55480	✓	E27	8	35	400	1900	90	×	125	180	8 / 24
SG-55481	✓	E27	6	30	320	1900	90	×	125	180	8 / 24

NEW

Our latest innovation from the Illusion Line. Here, two colours are seamlessly combined, making the LEDs an absolute eye-catcher even when switched off. When this special glass design is combined with our wafer-thin, ring-shaped filament, beautiful reflections are created that further enhance the illusion of floating light.

ILLUSION Line

2tones | E27



NEW

SG-55124
LED Illusion Globe 188
2tones amber blue
6 W / 300 lm / 1900 K



NEW

SG-55123
LED Illusion Globe 145
2tones amber blue
6 W / 300 lm / 1900 K



NEW

SG-55122
LED Illusion Globe 127
2tones amber blue
5 W / 250 lm / 1900 K



NEW

SG-55121
LED Illusion Globe 188
2tones black clear
6 W / 300 lm / 1900 K



NEW

SG-55120
LED Illusion Globe 145
2tones black clear
6 W / 300 lm / 1900 K



NEW

SG-55119
LED Illusion Globe 127
2tones black clear
5 W / 250 lm / 1900 K

Art.No	dim	Base	Watt	^Watt	Lumen	Kelvin	CRI	EEK	Ø	H	Pck
SG-55119	✓	E27	5	25	250	1900	>85	×	125	180	8 / 24
SG-55120	✓	E27	6	25	300	1900	>85	×	145	210	6 / 24
SG-55121	✓	E27	6	25	300	1900	>85	×	190	245	6 / 12
SG-55122	✓	E27	5	28	250	1900	>85	×	125	180	8 / 24
SG-55123	✓	E27	6	28	300	1900	>85	×	145	210	6 / 24
SG-55124	✓	E27	6	28	300	1900	>85	×	190	245	6 / 12



LINEAR Line

300 mm | S14d



SG-55173 LED Linear Lamp 300 | clear | 4,5 W | 300 lm | 2200 K



SG-55095 LED Linear Lamp 300 | clear | 6,2 W | 460 lm | 2700 K



SG-55096 LED Linear Lamp 300 frosted | 6,2 W | 460 lm | 2700 K



SG-55174 LED Linear Lamp 300 | golden | 4 W | 240 lm | 2200 K



SG-55184 LED Linear Lamp 300 | smokey grey | 6,5 W | 170 lm | 1900 K

Art.No	dim	Base	Watt	^Watt	Lumen	Kelvin	CRI	EEK	Ø	H	Pck
SG-55095	✓	S14d	6,2	39	460	2700	90	G	30	300	21 / 42
SG-55096	✓	S14d	6,2	39	460	2700	90	G	30	300	21 / 42
SG-55173	✓	S14d	4,5	28	300	2200	90	G	30	300	21 / 42
SG-55174	✓	S14d	4	30	330	2200	90	-	30	300	21 / 42
SG-55184	✓	S14d	6,5	18	170	1900	85	-	30	300	21 / 42



LINEAR Line

500 mm | S14d | E27



SG-55097 | LED Linear Lamp 500 | clear | 6,2 W | 460 lm | 2700 K



SG-55176 | LED Linear Lamp 500 | clear | 5 W | 350 lm | 2200 K



SG-55108 | LED Linear Lamp 500 | rippled clear | 6 W | 520 lm | 2200 K



SG-55109 | LED Linear Lamp 500 | rippled clear | 6,2 W | 460 lm | 2700 K



SG-55098 | LED Linear Lamp 500 | frosted | 6,2 W | 460 lm | 2700 K



SG-55177 | LED Linear Lamp 500 | golden | 4,5 W | 300 lm | 2200 K



SG-55188 | LED Linear Lamp 500 | smokey grey | 8 W | 220 lm | 1900 K



SG-55160 LED Linear Lamp rotatable 500 | clear | 5 W | 350 lm | 2200 K



Art.No	dim	Base	Watt	^Watt	Lumen	Kelvin	CRI	EEK	Ø	H	Pck
SG-55097	✓	S14d	6,2	39	460	2700	90	G	30	500	12 / 24
SG-55098	✓	S14d	6,2	39	460	2700	90	G	30	500	12 / 24
SG-55108	✓	S14d	6	43	520	2200	90	F	30	500	12 / 24
SG-55109	✓	S14d	6,2	39	460	2700	90	G	30	500	12 / 24
SG-55176	✓	S14d	5	32	350	2200	90	G	30	500	12 / 24
SG-55177	✓	S14d	4,5	28	300	2200	85	G	30	500	12 / 24
SG-55188	✓	S14d	8	22	220	1900	85	-	30	500	12 / 24
SG-55160	✓	E27	5	32	350	2200	90	G	30	500	12 / 24

NEW

© SEGULA GmbH

Art.No	dim	Base	Watt	^Watt	Lumen	Kelvin	CRI	EEK	Ø	H	Pck
SG-55440	✓	E14	4	30	400	2200	90	G	50	270	18 / 72
SG-55443	✓	E27	6	43	600	2200	90	G	50	600	18 / 72
SG-55445	✓	E27	10	50	1000	2200	90	G	50	1200	18 / 72
SG-55496	✓	E27	6	43	600	2200	90	G	50	450	18 / 72
SG-55498	✓	E27	8	48	800	2200	90	G	50	900	18 / 72
SG-55499	✓	E27	10	50	1000	2200	90	G	50	1200	18 / 72

ART Line 2.0

Flex | Straight | E27
clear

- Bendable in any shape
- After bending filament stays in the created position

SG-55440
LED Art Flexi 27
clear



NEW

SG-55443
LED Art Flexi 60
clear



NEW

NEW

SG-55445
LED Art Flexi 120
clear



NEW



SG-55499 | LED Art Straight 120 | clear

NEW



SG-55498 | LED Art Straight 90 | clear

NEW

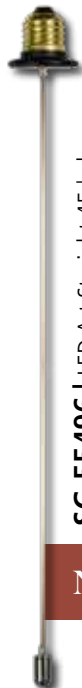

SG-55496 | LED Art Straight 45 | clear

NEW

- Flexible like a shoestring
- Magnetic at the end of the string



SOFT Line

Candle | Golf Ball | Bulb | Rustica | Globe | E14 | E27
Ambient Dimming | clear



SG-55300
LED Soft Candle
clear
3,3 W | 200 lm | 2000 - 2700 K



SG-55306
LED Soft Golf Ball
clear
3,3 W | 200 lm | 2000 - 2700 K



SG-55301
LED Soft Bulb
clear
6,2 W | 460 lm | 2000 - 2700 K



SG-55302
LED Soft Rustica
clear
6,2 W | 460 lm | 2000 - 2700 K



SG-55305
LED Soft Globe 125
clear
6,2 W | 460 lm | 2000 - 2700 K

Art.No	dim	Base	Watt	^Watt	Lumen	Kelvin	CRI	EEK	Ø	H	Pck
SG-55300	✓ambient	E14	3,3	21	200	2000 - 2700	90	G	35	100	24 / 96
SG-55301	✓ambient	E27	6,2	39	460	2000 - 2700	90	G	60	110	8 / 32
SG-55302	✓ambient	E27	6,2	39	460	2000 - 2700	90	G	65	145	24 / 48
SG-55305	✓ambient	E27	6,2	39	460	2000 - 2700	90	G	125	180	8 / 24
SG-55306	✓ambient	E27	3,3	21	200	2000 - 2700	90	G	45	72	12 / 48



SOFT Line

Tube | Candle | Golf Ball | Bulb | Globe
Ambient Dimming | E14 | E27



SG-55199
LED Soft Tube
frosted
6,2 W | 460 lm | 2000 - 2700 K



SG-55308
LED Soft Candle
milky frosted
3,3 W | 200 lm | 2000 - 2700 K



SG-55309
LED Soft Golf Ball
milky frosted
3,3 W | 200 lm | 2000 - 2700 K



SG-55303
LED Soft Bulb
frosted
6,2 W | 460 lm | 2000 - 2700 K



SG-55304
LED Soft Globe 125
frosted
6,2 W | 460 lm | 2000 - 2700 K

Art.No	dim	Base	Watt	^Watt	Lumen	Kelvin	CRI	EEK	Ø	H	Pck
SG-55199	✓ambient	E27	6,2	39	460	2000 - 2700	90	G	30	400	21 / 42
SG-55303	✓ambient	E27	6,2	39	460	2000 - 2700	90	G	60	110	8 / 32
SG-55304	✓ambient	E27	6,2	39	460	2000 - 2700	90	G	125	180	8 / 24
SG-55308	✓ambient	E14	3,3	21	200	2000 - 2700	90	G	35	100	24 / 48
SG-55309	✓ambient	E27	3,3	21	200	2000 - 2700	90	G	45	72	12 / 48



SG-50659
LED Soft Globe 80
clear
3,2 W | 190 lm | 2200 K



SG-50660
LED Soft Globe 95
clear
3,2 W | 190 lm | 2200 K



SG-50662
LED Soft Globe 125
clear
3,2 W | 190 lm | 2200 K

SOFT Line

Globe | Fridge Bulb | Tube | E14 | E27



SG-50412
LED Soft Tube
clear
3,2 W | 190 lm | 2200 K



SG-50635
LED Soft Radio Style
clear
3,2 W | 190 lm | 2200 K



SG-50414
LED Soft Tube
clear
3,2 W | 190 lm | 2200 K



SG-50641
LED Soft Bulb small
clear
3,2 W | 190 lm | 2200 K



SG-50643
LED Soft Bulb
clear
3,2 W | 190 lm | 2200 K

Art.No	dim	Base	Watt	^Watt	Lumen	Kelvin	CRI	EEK	Ø	H	Pck
SG-50659	✓	E27	3,2	20	190	2200	90	G	80	125	20 / 40
SG-50660	✓	E27	3,2	20	190	2200	90	G	95	140	12 / 24
SG-50662	✓	E27	3,2	20	190	2200	90	G	125	180	8 / 24
SG-50635	✓	E14	3,2	20	190	2200	90	G	45	100	12 / 48
SG-50641	✓	E27	3,2	20	190	2200	90	G	48	88	12 / 48
SG-50643	✓	E27	3,2	20	190	2200	90	G	60	110	8 / 32
SG-50412	✓	E14	3,2	20	190	2200	90	G	20	115	24 / 96
SG-50414	✓	E27	3,2	20	190	2200	90	G	45	112	8 / 32



SG-55198
LED Soft Tube
clear
8 W
500 lm
1900 K



SG-55362
LED Soft Tube
clear
6,2 W
460 lm
2700 K



SG-55382
LED Soft Tube
rippled clear
5 W
350 lm
2200 K



SG-55383
LED Soft Tube
rippled clear
6,2 W
460 lm
2700 K

SOFT Line

Long Tube

E27



SG-55420
LED Soft Tube
clear
6 W | 570 lm | 2200 K

NEW



SG-55363
LED Soft Tube
clear
6,2 W | 460 lm | 2700 K

NEW



SG-55418
LED Soft Tube
clear
6,5 W | 300 lm | 1900 K



SG-55396
LED Soft Tube
clear
6,5 W | 400 lm | 1900 K



SG-55419
LED Soft Tube Curved
clear
8 W | 400 lm | 1900 K



SG-55380
LED Soft Tube
rippled clear
4,5 W | 300 lm | 2200 K

Art.No	dim	Base	Watt	^Watt	Lumen	Kelvin	CRI	EEK	Ø	H	Pck
SG-55198	✓	E27	8	42	500	1900	90	×	30	550	12 / 24
SG-55362	✓	E27	6,2	39	460	2700	90	G	30	550	12 / 24
SG-55380	✓	E27	4,5	28	300	2200	90	G	30	360	21 / 42
SG-55382	✓	E27	5	32	350	2200	90	G	30	550	12 / 24
SG-55383	✓	E27	6,2	39	460	2700	90	G	30	550	12 / 24
SG-55396	✓	E27	6,5	35	400	1900	90	×	32	300	21 / 42
SG-55419	✓	E27	8	35	400	1900	90	×	32	300	21 / 42
SG-55363	✓	E27	6,2	39	460	2700	90	G	32	190	8 / 32
SG-55418	✓	E27	6,5	28	300	1900	90	×	32	190	8 / 32
SG-55420	✓	E27	6	46	570	2200	90	F	32	190	8 / 32



VINTAGE Line

Candle | Bulb | E14 | E27

Ambient Dimming



SG-55241
LED Vintage Candle
clear
3,2 W | 270 lm | 2000 - 2700 K



SG-55244
LED Vintage Bulb Small
clear
2,5 W | 200 lm | 2000 - 2700 K



SG-55248
LED Vintage Bulb
clear
6,5 W | 650 lm | 2000 - 2700 K



SG-55247
LED Vintage Bulb
milky frosted
6,5 W | 550 lm | 2000 - 2700 K

Art.No	dim	Base	Watt	^Watt	Lumen	Kelvin	CRI	EEK	Ø	H	Pck
SG-55241	✓ambient	E14	3,2	26	270	2000 - 2700	90	G	35	100	24 / 96
SG-55244	✓ambient	E27	2,5	21	200	2000 - 2700	90	G	48	88	12 / 48
SG-55247	✓ambient	E27	6,5	45	550	2000 - 2700	90	F	60	110	8 / 32
SG-55248	✓ambient	E27	6,5	51	650	2000 - 2700	90	F	60	110	8 / 32



SG-55263

LED Vintage Fridge Bulb
clear

1,5 W | 90 lm | 2200 K



SG-55638

LED Vintage Fridge Bulb
clear

1,5 W | 100 lm | 2700 K



SG-55204

LED Vintage Mini Bulb
clear

1,5 W | 90 lm | 2200 K



SG-55216

LED Vintage Radio Style
clear

3 W | 260 lm | 2200 K

VINTAGE Line

Fridge Lamp | Bulb | Radio Style | Tube | Drop Lamp

E14



SG-55264
LED Vintage Tube
clear
2,5 W | 200 lm | 2200 K



SG-55679
LED Vintage Tube
clear
2,5 W | 200 lm | 2700 K



SG-55711
LED Vintage Tube
frosted
2,5 W | 200 lm | 2700 K



SG-55321
LED Vintage Drop Lamp
clear
3 W | 260 lm | 2200 K



SG-55320
LED Vintage Drop Lamp
frosted
3 W | 260 lm | 2200 K



SG-55323
LED Vintage Drop Lamp
clear
3,2 W | 270 lm | 2700 K



SG-55322
LED Vintage Drop Lamp
frosted
3,2 W | 270 lm | 2700 K

Art.No	dim	Base	Watt	^Watt	Lumen	Kelvin	CRI	EEK	Ø	H	Pck
SG-55204	✓	E14	1,5	10	90	2200	90	G	35	65	24 / 96
SG-55216	✓	E14	3	26	260	2200	90	F	45	100	12 / 48
SG-55263	✓	E14	1,5	10	90	2200	90	G	26	60	70 / 140
SG-55264	✓	E14	2,5	21	200	2200	90	G	20	115	24 / 96
SG-55320	✓	E14	3	26	260	2200	90	F	48	88	12 / 48
SG-55321	✓	E14	3	26	260	2200	90	F	48	88	12 / 48
SG-55322	✓	E14	3,2	26	270	2700	90	G	48	88	12 / 48
SG-55323	✓	E14	3,2	26	270	2700	90	G	48	88	12 / 48
SG-55638	✓	E14	1,5	11	100	2700	90	G	26	60	70 / 140
SG-55679	✓	E14	2,5	21	200	2700	90	G	20	115	24 / 96
SG-55711	✓	E14	2,5	21	200	2700	90	G	20	115	24 / 96



SG-55206
LED Vintage Candle Flame
clear
3 W | 260 lm | 2200 K



SG-55207
LED Vintage Candle Flame
frosted
3 W | 260 lm | 2200 K



SG-55315
LED Vintage Candle Flame
clear
3,2 W | 270 lm | 2700 K



SG-55316
LED Vintage Candle Flame
frosted
3,2 W | 270 lm | 2700 K

VINTAGE Line

Candle
E14 | E27



SG-55230
LED Vintage French Candle
clear
1,5 W | 80 lm | 1900 K



SG-55201
LED Vintage Candle
clear
3 W
260 lm
2200 K



SG-55200
LED Vintage Candle
frosted
3 W
260 lm
2200 K



SG-55313
LED Vintage Candle
clear
3,2 W | 270 lm | 2700 K



SG-55312
LED Vintage Candle
frosted
3,2 W | 270 lm | 2700 K



SG-55314
LED Vintage Candle
clear
3,2 W | 270 lm | 2700 K

Art.No	dim	Base	Watt	^Watt	Lumen	Kelvin	CRI	EEK	Ø	H	Pck
SG-55200	✓	E14	3	26	260	2200	90	F	35	100	24 / 96
SG-55201	✓	E14	3	26	260	2200	90	F	35	100	24 / 96
SG-55206	✓	E14	3	26	260	2200	90	F	35	112	24 / 96
SG-55207	✓	E14	3	26	260	2200	90	F	35	112	24 / 96
SG-55230	✓	E14	1,5	9	80	1900	>85	×	22	88	70 / 140
SG-55312	✓	E14	3,2	26	270	2700	90	G	35	100	24 / 96
SG-55313	✓	E14	3,2	26	270	2700	90	G	35	100	24 / 96
SG-55314	✓	E27	3,2	26	270	2700	90	G	35	100	24 / 96
SG-55315	✓	E14	3,2	26	270	2700	90	G	35	112	24 / 96
SG-55316	✓	E14	3,2	26	270	2700	90	G	35	112	24 / 96



SG-55208
LED Vintage Golf Ball
clear
2,5 W | 200 lm | 2200 K



SG-55211
LED Vintage Bulb Small
clear
3 W | 260 lm | 2200 K



SG-55210
LED Vintage Bulb Small
frosted
3 W | 260 lm | 2200 K

VINTAGE Line

Golf Ball | Radio Style | Bulb
E27



SG-55327
LED Vintage Bulb
clear
3,2 W | 330 lm | 2700 K



SG-55325
LED Vintage Bulb
frosted
3,2 W | 330 lm | 2700 K



SG-55278
LED Vintage Bulb
clear
5 W | 400 lm | 2200 K



SG-55274
LED Vintage Bulb
frosted
5 W | 400 lm | 2200 K



SG-55337
LED Vintage Bulb
clear
6,5 W | 650 lm | 2700 K



SG-55335
LED Vintage Bulb
frosted
6,5 W | 650 lm | 2700 K



SG-55336
LED Vintage Bulb
milky
6,5 W | 550 lm | 2700 K



SG-55215
LED Vintage Radio Style
clear
5 W | 400 lm | 2200 K

Art.No	dim	Base	Watt	^Watt	Lumen	Kelvin	CRI	EEK	Ø	H	Pck
SG-55208	✓	E27	2,5	21	200	2200	90	G	45	72	12 / 48
SG-55210	✓	E27	3	26	260	2200	90	F	48	88	12 / 48
SG-55211	✓	E27	3	26	260	2200	90	F	48	88	12 / 48
SG-55215	✓	E27	5	35	400	2200	90	G	45	112	8 / 32
SG-55274	✓	E27	5	35	400	2200	90	G	60	110	8 / 32
SG-55278	✓	E27	5	35	400	2200	90	G	60	110	8 / 32
SG-55325	✓	E27	3,2	30	330	2700	90	F	60	110	8 / 32
SG-55327	✓	E27	3,2	30	330	2700	90	F	60	110	8 / 32
SG-55335	✓	E27	6,5	51	650	2700	90	F	60	110	8 / 32
SG-55336	✓	E27	6,5	45	550	2200	90	F	60	110	8 / 32
SG-55337	✓	E27	6,5	51	650	2700	90	G	60	110	8 / 32



VINTAGE Line

Rustica

E27



SG-55276
LED Vintage Rustica
golden
5 W | 400 lm | 2200 K

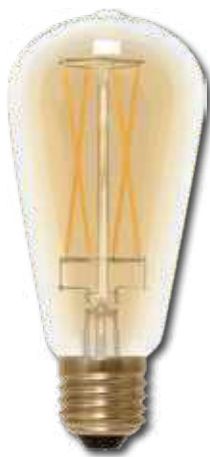

SG-55275
LED Vintage Rustica
golden
5 W | 400 lm | 2200 K



SG-55298
LED Vintage Rustica
clear
5 W | 400 lm | 2200 K

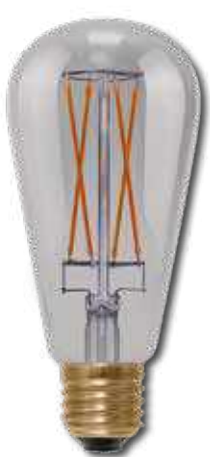

SG-55500
LED Vintage Rustica
smokey grey
5 W | 220 lm | 1900 K



SG-55700
LED Vintage Rustica
clear
6,5 W | 650 lm | 2700 K

Art.No	dim	Base	Watt	^Watt	Lumen	Kelvin	CRI	EEK	Ø	H	Pck
SG-55275	✓	E27	5	35	400	2200	90	G	65	145	24 / 48
SG-55276	✓	E27	5	35	400	2200	90	G	65	145	24 / 48
SG-55298	✓	E27	5	35	400	2200	90	G	65	145	24 / 48
SG-55500	✓	E27	5	22	220	1900	>85	×	65	140	24 / 48
SG-55700	✓	E27	6,5	51	650	2700	90	F	65	145	24 / 48



VINTAGE Line

Globe

E27



SG-55288

LED Vintage Globe 80

clear

5 W | 400 lm | 2200 K



SG-55271

LED Vintage Globe 80

golden

5 W | 400 lm | 2200 K



SG-55501

LED Vintage Globe 80

smokey grey

5 W | 220 lm | 1900 K



SG-55681

LED Vintage Globe 80

clear

6,5 W | 650 lm | 2700 K



SG-55682

LED Vintage Globe 80

milky

3,2 W | 330 lm | 2700 K

Art.No	dim	Base	Watt	^Watt	Lumen	Kelvin	CRI	EEK	Ø	H	Pck
SG-55271	✓	E27	5	35	400	2200	90	G	80	125	20 / 40
SG-55288	✓	E27	5	35	400	2200	90	G	80	125	20 / 40
SG-55501	✓	E27	5	22	220	1900	>85	×	80	125	20 / 40
SG-55681	✓	E27	6,5	51	650	2700	90	F	80	125	20 / 40
SG-55682	✓	E27	3,2	30	330	2700	90	F	80	125	20 / 40



VINTAGE Line

Globe 95

E27



SG-55282
LED Vintage Globe 95
clear
3 W | 260 lm | 2200 K



SG-55290
LED Vintage Globe 95
satin finish
3 W | 170 lm | 1900 K



SG-55680
LED Vintage Globe 95
clear
6,5 W | 650 lm | 2700 K



SG-55683
LED Vintage Globe 95
milky
3,2 W | 330 lm | 2700 K



SG-55283
LED Vintage Globe 95
clear
5 W | 400 lm | 2200 K



SG-55294
LED Vintage Globe 95
clear
5 W | 400 lm | 2200 K



SG-55272
LED Vintage Globe 95
golden
5 W | 400 lm | 2200 K



SG-55502
LED Vintage Globe 95
smokey grey
5 W | 220 lm | 1900 K

SHATTER-
PROOF

Art.No	dim	Base	Watt	^Watt	Lumen	Kelvin	CRI	EEK	Ø	H	Pck
SG-55272	✓	E27	5	35	400	2200	90	G	95	140	12 / 24
SG-55282	✓	E27	3	26	260	2200	90	F	95	140	12 / 24
SG-55283	✓	E27	5	35	400	2200	90	G	95	140	12 / 24
SG-55290	✓	E27	3	18	170	1900	90	×	95	140	12 / 24
SG-55294	✓	E27	5	35	400	2200	90	G	95	140	12 / 24
SG-55502	✓	E27	5	22	220	1900	>85	×	95	140	12 / 24
SG-55680	✓	E27	6,5	51	650	2700	90	F	95	140	12 / 24
SG-55683	✓	E27	3,2	30	330	2700	90	F	95	140	12 / 24



SG-55509
LED Vintage Globe 125
half moon frosted
6,5 W | 650 lm | 2700 K



SG-55675
LED Vintage Globe 125
satin finish
6,5 W | 650 lm | 2700 K



SG-55286
LED Vintage Globe 125
clear
5 W | 400 lm | 2200 K



SG-55503
LED Globe 125
smokey grey
5 W / 220 lm / 1900 K



SG-55273
LED Vintage Globe 125
golden
5 W | 400 lm | 2200 K

Art.No	dim	Base	Watt	^Watt	Lumen	Kelvin	CRI	EEK	Ø	H	Pck
SG-55273	✓	E27	5	35	400	2200	90	G	125	180	8 / 24
SG-55503	✓	E27	5	22	220	1900	>85	G	125	180	8 / 24
SG-55286	✓	E27	5	35	400	2200	90	G	125	180	8 / 24
SG-55509	✓	E27	6,5	51	650	2700	90	F	125	180	8 / 24
SG-55675	✓	E27	6,5	51	650	2700	90	F	125	180	8 / 24

VINTAGE Line

Globe

E27



SG-55685

LED Vintage Globe 125
clear
6,5 W | 650 lm | 2700 K



SG-55684

LED Vintage Globe 125
milky
6,5 W | 650 lm | 2700 K



SG-55689

LED Vintage Globe 150
clear
6,5 W | 650 lm | 2700 K



SG-55690

LED Vintage Globe 150
milky frosted
6,5 W | 650 lm | 2700 K

Art.No	dim	Base	Watt	^Watt	Lumen	Kelvin	CRI	EEK	Ø	H	Pck
SG-55684	✓	E27	6,5	51	650	2700	90	F	125	180	8 / 24
SG-55685	✓	E27	6,5	51	650	2700	90	F	125	180	8 / 24
SG-55689	✓	E27	6,5	51	650	2700	90	F	150	235	6 / 24
SG-55690	✓	E27	6,5	51	650	2700	90	F	150	235	6 / 24



SG-55370
LED Vintage Drop Lamp
Mirror Head silver
2,5 W | 200 lm | 2700 K



SG-55366
LED Vintage Bulb A67
Mirror Head silver
6,5 W | 550 lm | 2700 K



VINTAGE Line

Mirror head | Drop Lamp | Bulb | Globe

E14 | E27



SG-55369
LED Vintage Bulb
Mirror Head silver
3,2 W | 270 lm | 2700 K



SG-55488
LED Vintage Bulb
Mirror Head golden
3,2 W | 270 lm | 2700 K



SG-55489
LED Vintage Bulb
Mirror Head copper
3,2 W | 270 lm | 2700 K



SG-55490
LED Vintage Globe 125
Mirror Head silver
6,5 W | 550 lm | 2700 K



SG-55491
LED Vintage Globe 125
Mirror Head golden
6,5 W | 550 lm | 2700 K



SG-55492
LED Vintage Globe 125
Mirror Head copper
6,5 W | 550 lm | 2700 K

Art.No	dim	Base	Watt	^Watt	Lumen	Kelvin	CRI	EEK	Ø	H	Pck
SG-55366	✓	E27	6,5	45	550	2700	90	F	67	135	8 / 32
SG-55369	✓	E27	3,2	26	270	2700	90	G	60	110	8 / 32
SG-55370	✓	E14	2,5	21	200	2700	90	G	48	85	12 / 48
SG-55488	✓	E27	3,2	26	270	2700	90	G	60	110	8 / 32
SG-55489	✓	E27	3,2	26	270	2700	90	G	60	110	8 / 32
SG-55490	✓	E27	6,5	45	550	2700	90	F	125	180	8 / 24
SG-55491	✓	E27	6,5	45	550	2700	90	F	125	180	8 / 24
SG-55492	✓	E27	6,5	45	550	2700	90	F	125	180	8 / 24



SG-50800
LED Bright Mini Tube
clear
3,5 W | 350 lm | 2700 K



SG-50803
LED Bright Mini Tube
frosted
3,5 W | 350 lm | 2700 K



SG-55801
LED Bright Tube
clear
6,7 W | 780 lm | 2700 K



SG-55802
LED Bright Tube
clear
6,7 W | 780 lm | 2700 K



SG-55807
LED Bright Tube
frosted
6,7 W | 780 lm | 2700 K



SG-55805
LED Bright Bulb
clear
7,5 W | 900 lm | 2700 K



SG-55806
LED Bright Bulb
frosted
7,5 W | 900 lm | 2700 K



SG-55804
LED Bright Radio Style
clear
7,5 W | 900 lm | 2700 K



SG-55809
LED Bright Mini Ellipse
clear
7,5 W | 900 lm | 2700 K

Art.No	dim	Base	Watt	^Watt	Lumen	Kelvin	CRI	EEK	Ø	H	Pck
SG-50800	✓	E14	3,5	32	350	2700	90	F	25	85	24 / 96
SG-50803	✓	E14	3,5	32	350	2700	90	F	25	80	24 / 96
SG-55801	✓	E14	6,7	58	780	2700	90	E	32	110	24 / 96
SG-55802	✓	E27	6,7	58	780	2700	90	E	32	115	24 / 96
SG-55807	✓	E27	6,7	58	780	2700	90	E	32	115	24 / 96
SG-55804	✓	E27	7,5	66	900	2700	90	E	45	115	8 / 32
SG-55805	✓	E27	7,5	66	900	2700	90	E	62	110	8 / 32
SG-55806	✓	E27	7,5	66	900	2700	90	E	62	110	8 / 32
*SG-55809	✓	E27	7,5	66	900	2700	90	E	56	120	8 / 32

BRIGHT Line

E14 | E27



SG-55894
LED Bright Ellipse
clear
14 W | 1550 lm | 2700 K



SG-55593
LED Bright Globe 125
clear
14 W | 1100 lm | 1900 K



SG-55590
LED Bright Tube Slim
clear
11 W | 1250 lm | 2700 K



SG-55598
LED Bright Tube
clear
14 W | 1550 lm | 2700 K

Art.No	dim	Base	Watt	^Watt	Lumen	Kelvin	CRI	EEK	Ø	H	Pck
SG-55593	✓	E27	14	77	1100	1900	>85	×	125	210	8 / 24
SG-55894	✓	E27	14	102	1550	2700	90	E	90	240	8 / 16
SG-55590	✓	E27	11	85	1250	2700	90	E	32	175	8 / 32
SG-55598	✓	E27	14	102	1550	2700	90	E	45	170	8 / 32



SG-55222
LED Bright Reflector MR16
clear
7 W | 500 lm | 2000-3000 K



SG-55220
LED Bright Reflector
clear
7 W | 380 lm | 1700-2800 K



SG-55765
LED Bright G4 Pin
clear
2,5 W | 200 lm | 2000 - 2700 K



SG-55760
LED Bright G4 Pin
clear
2,5 W | 230 lm | 2200 K



SG-55761
LED Bright G4 Pin
clear
2,5 W | 200 lm | 2700 K

Art.No	dim	Base	Watt	^Watt	Lumen	Kelvin	CRI	EEK	Ø	H	Pck
SG-55220	✓ambient	GU10	7	35	380	1700-2800	95	G	49	58	10 / 40
SG-55222	✓ambient	GU5.3	7	45	500	2000-3000	90	G	50	49	10 / 40
SG-55760	✓	G4	2,5	23	230	2200	90	F	12	45	70 / 140
SG-55761	✓	G4	2,5	21	200	2700	90	G	12	45	70 / 140
SG-55765	✓ambient	G4	2,5	21	200	2000 - 2700	90	G	12	45	70 / 140

BRIGHT Line

Reflector | Pin | G4 | GU5.3 | G9



SG-55604
LED Bright G9 Pin
clear
2,5 W | 250 lm | 2000-2700 K



SG-55607
LED Bright G9 Pin
clear
1,5 W | 90 lm | 2200 K



SG-55608
LED Bright G9 Pin
clear
2,5 W | 200 lm | 2200 K



SG-55609
LED Bright G9 Pin
clear
1,5 W | 100 lm | 2700 K



SG-55610
LED Bright G9 Pin
clear
2,5 W | 200 lm | 2700 K



SG-55615
LED Bright G9 Pin
frosted
3 W | 260 lm | 2200 K



SG-55616
LED Bright G9 Pin
frosted
4,5 W | 350 lm | 2200 K



SG-55617
LED Bright G9 Pin
frosted
3,2 W | 270 lm | 2700 K



SG-55618
LED Bright G9 Pin
frosted
4,5 W | 400 lm | 2700 K

Art.No	dim	Base	Watt	^Watt	Lumen	Kelvin	CRI	EEK	Ø	H	Pck
SG-55607	✓	G9	1,5	10	90	2200	90	G	14	57	70 / 140
SG-55608	✓	G9	2,5	21	200	2200	90	G	14	68	70 / 140
SG-55609	✓	G9	1,5	11	100	2700	90	G	14	57	70 / 140
SG-55610	✓	G9	2,5	21	200	2700	90	G	14	68	70 / 140
SG-55615	✓	G9	3	26	260	2200	90	F	20	70	70 / 140
SG-55616	✓	G9	4,5	32	350	2200	90	G	20	70	70 / 140
SG-55617	✓	G9	3,2	26	270	2700	90	G	20	70	70 / 140
SG-55618	✓	G9	4,5	35	400	2700	90	F	20	70	70 / 140
SG-55604	✓ ambient	G9	2,5	25	250	2000-2700	90	F	15	70	70 / 140



IL-90117
Bulb
GU10
5,7 W / 600 lm / 2700 K



IL-90120
Bulb
GU10
5,7 W / 600 lm / 3000 K



IL-90109
Bulb
GU10
3,6 W / 400 lm / 2700 K



IL-90100
Bulb
GU10
4,9 W / 520 lm / 2700 K



IL-90086
Glass Bulb
GU10
3,6 W / 400 lm / 2700 K



IL-90112
High cri 95 Bulb
GU10
5 W / 400 lm / 3000 K

Art.No.	dim	Base	Watt	Lumen	Kelvin	CRI	EEK	Ø	H	Pck
IL-90117	yes	GU10	5,7	600	2700	CRI 80	E	50	54	10/100
IL-90120	yes	GU10	5,7	600	3000	CRI 80	E	50	54	10/100
IL-90109	yes	GU10	3,6	400	2700	CRI 80	E	50	54	10/100
IL-90100	yes	GU10	4,9	520	2700	CRI 80	E	50	54	10/100
IL-90086	yes	GU10	3,6	400	2700	CRI 80	E	50	54	10/100
IL-90112	yes	GU10	5	400	3000	CRI +90	G	50	54	10/100

BRIGHT Line

GU10 | MR11 | MR16



IL-90003
EVOLIGHT
220V-230V
3,8 W / 410 lm / 2700 K



IL-90009
Bulb 12V
MR11
3,7 W / 380 lm / 2700 K



IL-90011
Bulb 230V
MR11-GU10
3,2 W / 330 lm / 2700 K

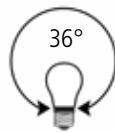

IL-90047
Glass MR16 Bulb
MR16
4,4 W / 400 lm / 2700 K



IL-90121
Warmtone Glass Bulb
GU10
3,6 W / 400 lm / 1800- 2700 K

Art.No.	dim	Base	Watt	Lumen	Kelvin	CRI	EEK	Ø	H	Pck
IL-90003	yes	/	3,8	410	2700	CRI 80	E	50	29	10/100
IL-90009	no	MR11	3,7	380	2700	CRI 80	E	35	38	10/100
IL-90011	yes	MR11/GU10	3,2	410	2700	CRI 80	E	35	35	10/100
IL-90047	yes	MR16	4,4	400	2700	CRI 80	E	35	48	10/100
IL-90121	yes	GU10	3,6	400	1800-2700	CRI 80	E	50	54	10/100



SG-70133

black
Pendant Lamp
ALIX WAVE 1 m



These elegant lamps consist of a pendant with fabric cable in various lengths, composit socket and metal canopy.

CUSTOM Line

Alix Wave

E27

SG-70134

black
Pendant Lamp
ALIX WAVE 2 m



SG-70135

black
Pendant Lamp
ALIX WAVE 3 m



SG-70136

black
Pendant Lamp
ALIX WAVE 4 m



SG-70137

black
Pendant Lamp
ALIX WAVE 5 m



Art.No	Socket	Cable Measure	Canopy (mm)	Socket (mm)	Measure (mm)	Pck
SG-70133	E27	1 m	Ø 83 x H 22	Ø 50 x H 90	x	5 / 25
SG-70134	E27	2 m	Ø 83 x H 22	Ø 50 x H 90	x	5 / 25
SG-70135	E27	3 m	Ø 83 x H 22	Ø 50 x H 90	x	5 / 25
SG-70136	E27	4 m	Ø 83 x H 22	Ø 50 x H 90	x	5 / 25
SG-70137	E27	5 m	Ø 83 x H 22	Ø 50 x H 90	x	5 / 25





CUSTOM Line

Madox Wave

E27

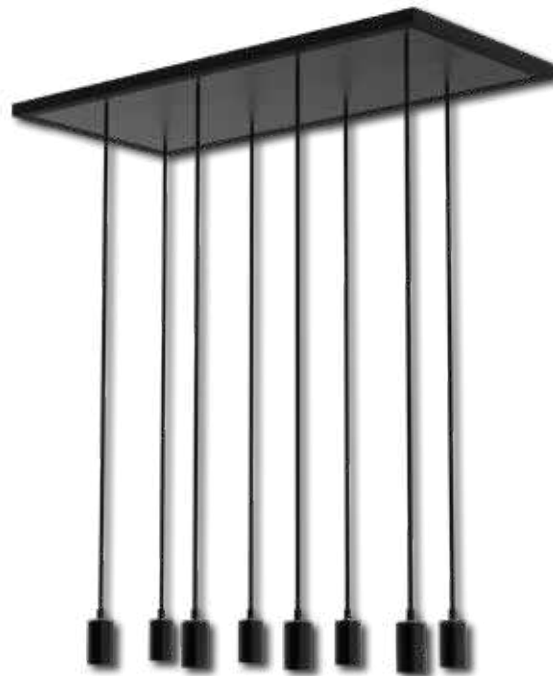

SG-70169
Pendant Lamp MADOX
8-WAVE (8 x 1,5 m)



SG-70167
Pendant Lamp MADOX
3-WAVE (3 x 1,5 m)



SG-70168
Pendant Lamp MADOX
5-WAVE (5 x 1,5 m)

Art.No	Socket	Cable Measure	Canopy (mm)	Socket (mm)	Measure (mm)	Pck
SG-70167	3 x E27	3 x 1,5 m	1000 x 150 x 25	Ø 50 x H 90	x	5 / 10
SG-70168	5 x E27	5 x 1,5 m	1000 x 150 x 25	Ø 50 x H 90	x	3 / 6
SG-70169	8 x E27	8 x 1,5 m	1000 x 450 x 25	Ø 50 x H 90	x	3 / 6



PLUG-AND-PLAY:
DIMSYSTEEM
SYSTÈME
DE DIMMING

**MET INTUÏTIEVE
BEDIENING
& ONEINDIG VEEL
UITBREIDINGS-
MOGELIJKHEDEN**

**AVEC
FONCTIONNEMENT
INTUITIF ET POSSIBILITÉS
D'EXTENSION
ILLIMITÉES**



SERIES USP

**TOUCHPANELS
MET EIGEN DESIGN,
MAXIMAAL
BEDIENGE Mak**

**LICHTSCÈNES
INSTELLEN
EN ACTIVEREN MET
ÉÉN DRUK OP DE KNOP**

BETROUWBAAR

Het systeem is schaalbaar en uit te breiden met:

- Relais (Schakelen en/of Screen-, en Motorsturing)
- DALI uitgang.
- DMX regeling (in en uit).
- RS232 koppeling voor bijvoorbeeld Crestron en AMX.
- LED-drivers.
- 0(1)-10V sturingen.
- KNX

EIGENSCHAPPEN

- 16 Bit oftewel 65.536 stappen voor perfect en volledig naar nul dimmen.
- Geen minimale belasting.
- Stabiel bij frequentie- en spanning schommeling & geschikt voor generator gebruik 45-65 Hz.
- Waarborging verlichting; altijd te bedienen met de potmeters op de dimmers.
- Continue diagnose van de aangesloten voeding en belastingen.
- Elektronische beveiliging tegen kortsluiting van vaste uitgangen < 10 ms.
- Crossfade 0-30 sec. tussen de presets, afzonderlijk instelbaar voor de presets 1-4, 5-8 & 9-12.

**ECRANS TACTILES
AVEC VOTRE PROPRE
MISE EN PAGE/
DISPOSITION POUR UN
MAXIMUM DE FACILITE
D'UTILISATION**

**DÉFINISSEZ VOS
PROPRES SCENARIOS
D'ECLAIRAGE**

FIABILITÉ

Le système est évolutif et extensible avec:

- Relais (de commutation et/ou d'écran, et de contrôle de moteur).
- Sortie DALI. • Contrôle DMX (entrée et sortie).
- Liaison RS232 pour Crestron et AMX par exemple.
- Drivers LED.
- Contrôles 0(1)-10V.
- KNX

CARACTERISTIQUES

- 16 bits ou 65 536 niveaux pour un dimming parfait de 0 à 100.
- Pas de charge minimale.
- Stabilité de la fréquence et de la tension, convient au fonctionnement des compteurs 45-65 H
- garantie de luminosité; toujours gérable avec les potentiomètres des dimmers.
- Diagnostic continu des alimentations et charges connectées
- Sorties fixes en court-circuit, court-circuit électronique protection < 10 ms.
- Fondu-enchaîné 0-30 sec. entre les présélections, réglable individuellement pour les présélections 1-4, 5-8 & 9-12.



PROFESSIONELE DIMMER VARIATEUR PROFESSIONNEL

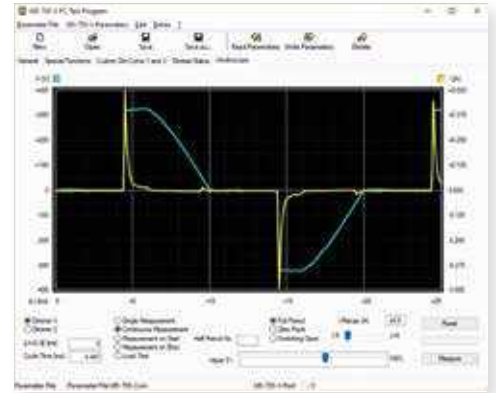

**PERFECT
DIMMEN
VAN SEGULA**



**PARFAITEMENT
DIMMABLE
AVEC
SEGULA**

AUTOMATISCHE DIMINSTELLING

- De universele dimmer herkent automatisch of de aangesloten belasting d.m.v. fase aan- of afsnijding gedimd dient te worden.
- Dimmer is bruikbaar als 2x 700 Watt of 1x 1400 Watt.
- Dimmers zijn in staat om piekstromen te verwerken van 2x 8A of 1x 16A.

INGEBOUWDE OSCILLOSCOOP

- Betrouwbare installatie
- Realtime inzicht in o.a. spanning, stroom, temperatuur, belasting, etc.
- Automatisch of zelf instellingen bepalen via de **GRATIS** software.

REGLAGE D'INTENSITE

- Le variateur universel reconnaît automatiquement si la charge connectée doit être diminuée au moyen de la phase ou si cela doit être varié via la coupure.
- Le variateur peut supporter 2x 700 Watt ou en 1x 1400 Watt.
- Les variateurs sont capables de supporter des courants de pointe de 2x 8A ou 1x 16A.

OSCILLOSCOPE INTÉGRÉ

- INSTALLATION FIABLE
- APERCU EN TEMPS RÉEL de la tension, du courant, de la température, de la charge, etc.
- Laissez le dimmer déterminer les paramètres ou faites vos propres réglages grâce au logiciel **GRATUIT**.

UNIVERSEEL

voor retrofit LED en overige
Ohmse, Inductieve
& Capacitieve lasten

STAND-ALONE

DMX (RDM) / DALI / 0(1)-10V
(Draai- of druknop)
Casambi

UNIVERSEL

pour LED retrofit et autres
charges Ohmiques, Inductives
et Capacitives

AUTONOME

EN DMX (RDM) / DALI / 0(1)-10V
(tourner ou appuyer sur le bouton)
Casambi

UD-700-X2

UD-700-X2-DALI

UD-700-X2-ROM

UD-700-X2-DALI-C (Casambi-ready)

Art.No.

80026503

80026504

80026505

80026506

Watt

2 x 700 W

2 x 700 W

2 x 700 W

2 x 700 W

Dimensions (HxWxD) mm

90 x 106 x 59, REG (6 TE)

90 x 106 x 59, REG (6 TE)

90 x 106 x 59, REG (6 TE)

90 x 106 x 59, REG (6 TE)

Pck

1

1

1

1



**LIGHT
TECHNOLOGY
NEDERLAND**

PERLUCI





PLC-10905
CANA
white
Max: 60W



PLC-10908
HIBO
Black
Max: 60W



PLC-10907
HIBO
white
Max: 60W



PLC-11101
WALY
white
Max: 60W



PLC-11102
WALY
Black
Max: 60W



PLC-20120
Linear single S14D
Metal white



PLC-20121
Linear single S14D
Metal black



PLC-20122
Linear single S14D
Gold



PLC-20124
Linear single S14D
Red bronzed



PLC-20125
Linear single S14D
Matt brass

Art.No.

PLC-10905

PLC-10907

PLC-10908

PLC-11101

PLC-11102

PLC-20120

PLC-20121

PLC-20122

PLC-20124

PLC-20125

Type

Cana

Hibo

Hibo

Waly

Waly

Metal white

Metal black

Gold

Red bronzed

Matt brass

Housing

White ceramic

White ceramic

Black ceramic

White ceramic

Black ceramic

S14D

S14D

S14D

S14D

S14D

Socket

E27

E27

E27

E27

E27

70x46x40 mm

70x46x40 mm

70x46x40 mm

70x46x40 mm

70x46x40 mm

Watt

Max 60W

Max 60W

Max 60W

Max 60W

Max 60W

Wall

Wall

Wall

Wall

Wall

Dimensions

11x11x5,5 cm

10x10x5,5 cm

10x10x5,5 cm

8x7,5x8 cm

8x7,5x8 cm

25/50

25/50

25/50

25/50

25/50

Mouting

Wall / Ceiling

Wall / Ceiling

Wall / Ceiling

Wall

Wall

-

-

-

-

-

Pck

10/25

10/25

10/25

10/25

10/25

25/50

25/50

25/50

25/50

25/50



Linkable



Non -Linkable

PLC-30012 / PLC-30015

Rubber
incl. 2 plugs

PLC-30013 / PLC-30014

Rubber

Art.No.	Outdoor	Color	Linkable	Sockets	Power	Length	Pck
PLC-30012	rubber	Black	linkable: IP44	incl. 10 sockets E27	incl. 2 plugs	10m	5/10
PLC-30013	rubber	Black	non linkable: IP44	incl. 10 sockets E27	-	10m	5/10
PLC-30014	rubber	Black	non linkable: IP44	incl. 20 sockets E27	-	10m	5/10
PLC-30015	rubber	Black	linkable: IP44	incl. 20 sockets E27	incl. 2 plugs	10m	5/10



PLC-50912

LED G45 Bulb
Frosted
1W / 32 lm / 2000 K



PLC-50910

LED G45 Bulb
Frosted
1W / 32 lm / 2650 K



SG-55209

LED Vintage Golf Ball
Clear
1,5W / 90 lm / 2200 K

**IMPACT RESISTANT
SYNTHETIC**

Art.No.	dim	Base	Watt	^Watt	Lumen	Kelvin	CRI	EEK	Ø	H	Pck
PLC-50912	no	E27	1	32	15	2000	CRI >80	F	45	72	10/100
PLC-50910	no	E27	1	32	15	2650	CRI >80	F	45	72	10/100
SG-55209	yes	E27	1,5	10	9	2200	CRI 90	G	45	70	12/48



WALL DIMMER & CABLE DIMMER

PLC-10608

Led wall dimmer (excl. cover)
compatible with other brands covers



PLC-60101

Cable dimmer
Foot switch
white



PLC-60102

Cable dimmer
Foot switch
Black



PLC-60104

Cable dimmer
push switch
black



PLC-60103

Cable dimmer
push switch
white

Art.No.	dimmer	Watt	Dimensions	Pck
PLC-10608	Led wall	min: 0.3W / max: 200W	l 71 x b 71.5 x h 21 mm	5/10
PLC-60101	cable	LED 1-100W	Ø 80 x h 19,5 mm	5/10
PLC-60102	cable	LED 1-100W	Ø 80 x h 19,5 mm	5/10
PLC-60103	cable	LED 1-100W	l 72 x b 32.5 x h 17.5 mm	5/10
PLC-60104	cable	LED 1-100W	l 72 x b 32.5 x h 17.5 mm	5/10

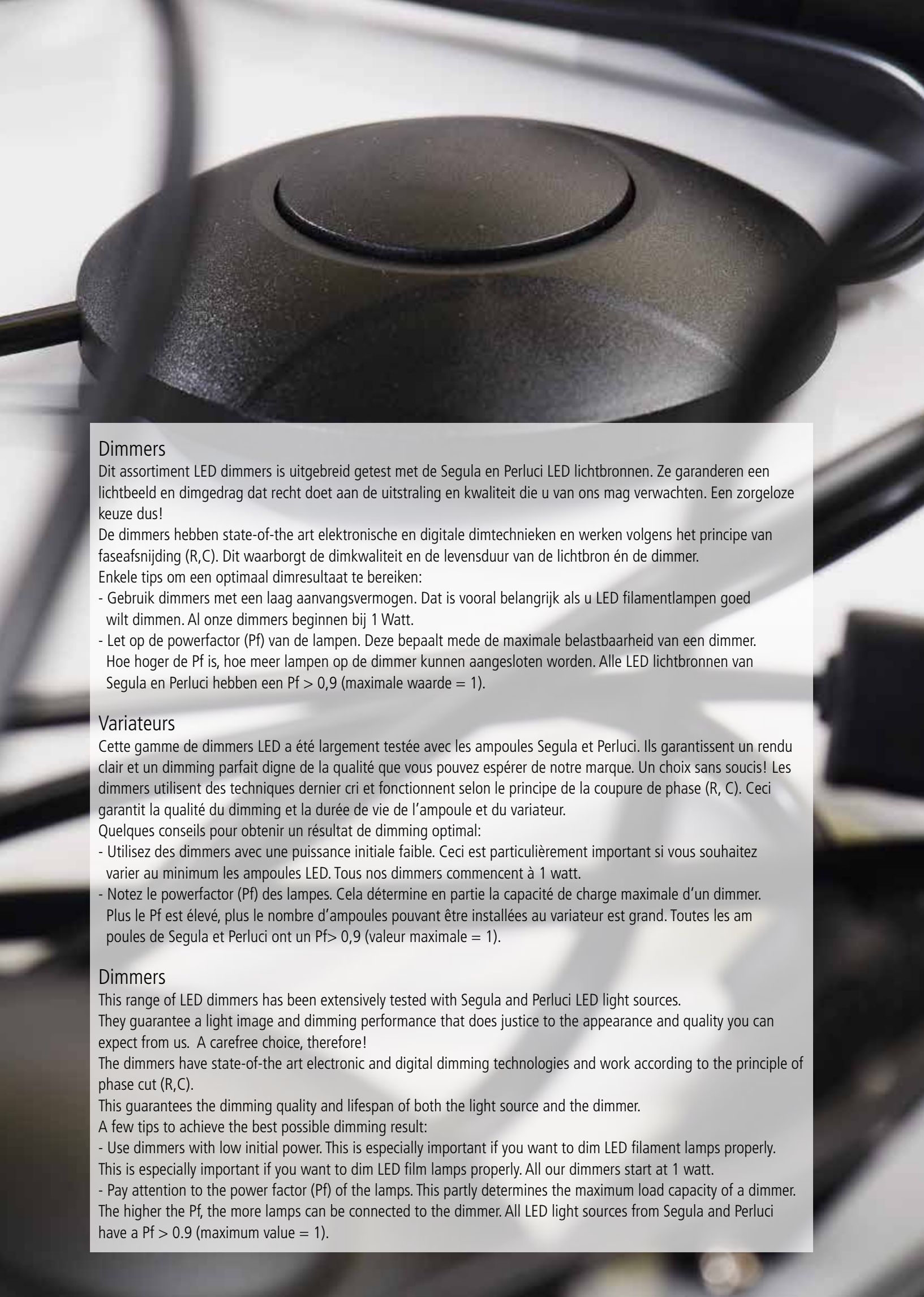

Dimmers

Dit assortiment LED dimmers is uitgebreid getest met de Segula en Perluci LED lichtbronnen. Ze garanderen een lichtbeeld en dimgedrag dat recht doet aan de uitstraling en kwaliteit die u van ons mag verwachten. Een zorgeloze keuze dus!

De dimmers hebben state-of-the art elektronische en digitale dimtechnieken en werken volgens het principe van faseafsnijding (R,C). Dit waarborgt de dimkwaliteit en de levensduur van de lichtbron én de dimmer.

Enkele tips om een optimaal dimresultaat te bereiken:

- Gebruik dimmers met een laag aanvangsvermogen. Dat is vooral belangrijk als u LED filamentlampen goed wilt dimmen. Al onze dimmers beginnen bij 1 Watt.
- Let op de powerfactor (Pf) van de lampen. Deze bepaalt mede de maximale belastbaarheid van een dimmer. Hoe hoger de Pf is, hoe meer lampen op de dimmer kunnen aangesloten worden. Alle LED lichtbronnen van Segula en Perluci hebben een $Pf > 0,9$ (maximale waarde = 1).

Variateurs

Cette gamme de dimmers LED a été largement testée avec les ampoules Segula et Perluci. Ils garantissent un rendu clair et un dimming parfait digne de la qualité que vous pouvez espérer de notre marque. Un choix sans soucis! Les dimmers utilisent des techniques dernier cri et fonctionnent selon le principe de la coupure de phase (R, C). Ceci garantit la qualité du dimming et la durée de vie de l'ampoule et du variateur.

Quelques conseils pour obtenir un résultat de dimming optimal:

- Utilisez des dimmers avec une puissance initiale faible. Ceci est particulièrement important si vous souhaitez varier au minimum les ampoules LED. Tous nos dimmers commencent à 1 watt.
- Notez le powerfactor (Pf) des lampes. Cela détermine en partie la capacité de charge maximale d'un dimmer. Plus le Pf est élevé, plus le nombre d'ampoules pouvant être installées au variateur est grand. Toutes les ampoules de Segula et Perluci ont un $Pf > 0,9$ (valeur maximale = 1).

Dimmers

This range of LED dimmers has been extensively tested with Segula and Perluci LED light sources.

They guarantee a light image and dimming performance that does justice to the appearance and quality you can expect from us. A carefree choice, therefore!

The dimmers have state-of-the art electronic and digital dimming technologies and work according to the principle of phase cut (R,C).

This guarantees the dimming quality and lifespan of both the light source and the dimmer.

A few tips to achieve the best possible dimming result:

- Use dimmers with low initial power. This is especially important if you want to dim LED filament lamps properly. This is especially important if you want to dim LED film lamps properly. All our dimmers start at 1 watt.
- Pay attention to the power factor (Pf) of the lamps. This partly determines the maximum load capacity of a dimmer. The higher the Pf, the more lamps can be connected to the dimmer. All LED light sources from Segula and Perluci have a $Pf > 0.9$ (maximum value = 1).



PLC-50770
 Ambient Dimming Reflector
 AR 70
 7 W / 300 lm / 2000 - 2800 K
 incl compact driver



PLC-50717
 Constant Current
 AR 111
 15 W / 700 lm / 2700 K
 incl compact driver



PLC-50719
 Ambient Dimming Reflector
 AR 111
 15 W / 650 lm / 2000 - 3000 K
 incl compact driver



Art.No.	dim	Base	Watt	^Watt	Lumen	Kelvin	CRI	EEK	Ø	H	Pck
PLC-50770	Yes	B15D	7	40	300	2000 - 2800	CRI >92	F	70	45	10/30
PLC-50717	Yes	G53	15	75	700	2700	CRI >92	F	111	70	10/30
PLC-50719	Yes	G53	15	75	650	2000 - 3000	CRI >90	F	111	70	10/30

C E I L I N G P l a t e s

by

PERLUCI



Het huismerk van Quality LEDs biedt u de mogelijkheid om uw verlichtingsproject te personaliseren. Onze in België gemaakte plafondplaten zorgen ervoor dat uw projecten net dat tikkeltje meer krijgen!

La marque propre de Quality LEDs vous offre la possibilité de personnaliser votre projet d'éclairage. Fabriquées en Belgique, nos bases de plafond donneront à vos projets le petit plus qui fait la différence !

Quality LEDs' own brand offers you the opportunity to personalize your lighting project. Made in Belgium, our ceiling plates will give your projects just that extra touch!

RECTANGULAR CEILING BASE 130x8x3,5cm



- PLC-130081-0 Black 130cm ceiling base without holes and excl. accessories
- PLC-130082-0 White 130cm ceiling base without holes and excl. accessories



- Easy to install**
- Ready to connect**
- Metal cable clamp**
- Powder coated steel**

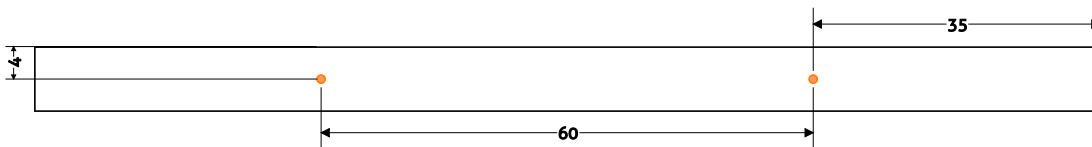

- PLC-130081-2 Black 130cm ceiling base with 2 holes and incl. accessories*
- PLC-130082-2 White 130cm ceiling base with 2 holes and incl. accessories*

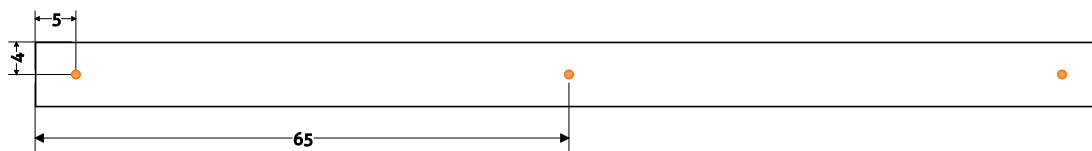

- PLC-130081-3 Black 130cm ceiling base with 3 holes and incl. accessories*
- PLC-130082-3 White 130cm ceiling base with 3 holes and incl. accessories*

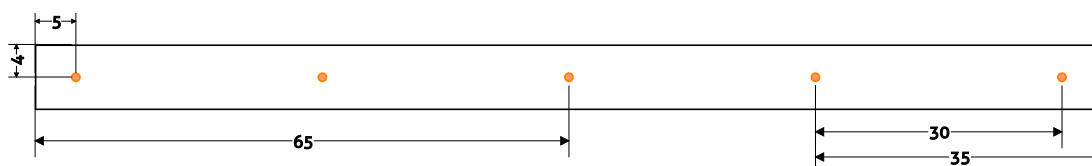

- PLC-130081-5 Black 130cm ceiling base with 5 holes and incl. accessories*
- PLC-130082-5 White 130cm ceiling base with 5 holes and incl. accessories*

all measurements are in cm
* incl. Wago and cable clamp connection kit

RECTANGULAR CEILING BASE 160x8x3,5cm



PLC-160081-0 Black 160cm ceiling base without holes and excl. accessories
 PLC-160082-0 White 160cm ceiling base without holes and excl. accessories



Easy to install **Ready to connect** **Metal cable clamp** **Powder coated steel**

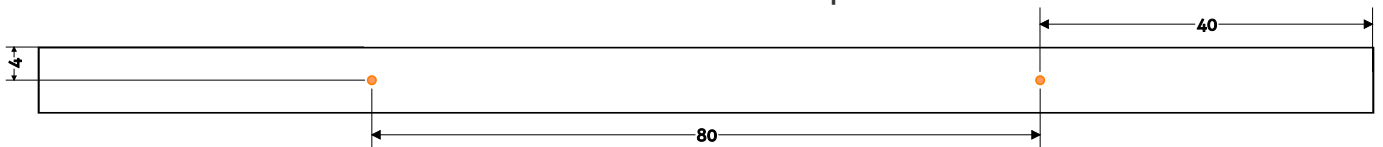

PLC-160081-2 Black 160cm ceiling base with 2 holes and incl. accessories*
 PLC-160082-2 White 160cm ceiling base with 2 holes and incl. accessories*

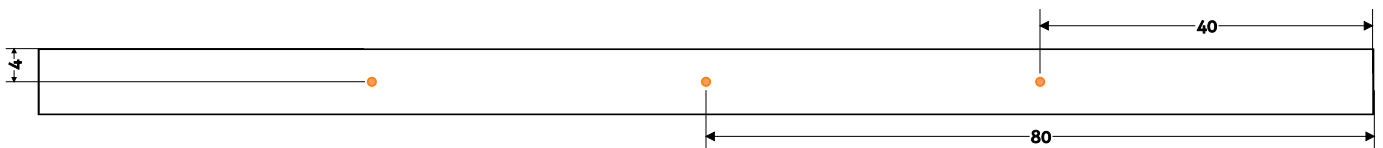

PLC-160081-3 Black 160cm ceiling base with 3 holes and incl. accessories*
 PLC-160082-3 White 160cm ceiling base with 3 holes and incl. accessories*

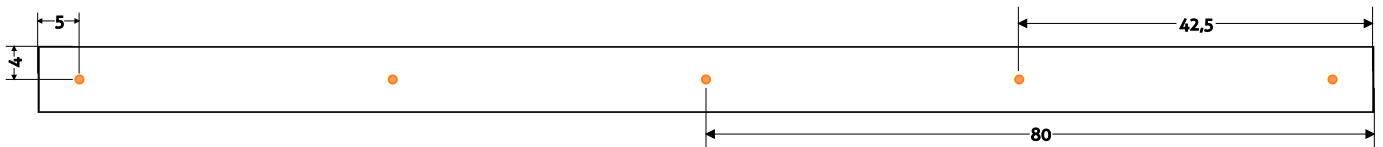

PLC-160081-5 Black 160cm ceiling base with 5 holes and incl. accessories*
 PLC-160082-5 White 160cm ceiling base with 5 holes and incl. accessories*

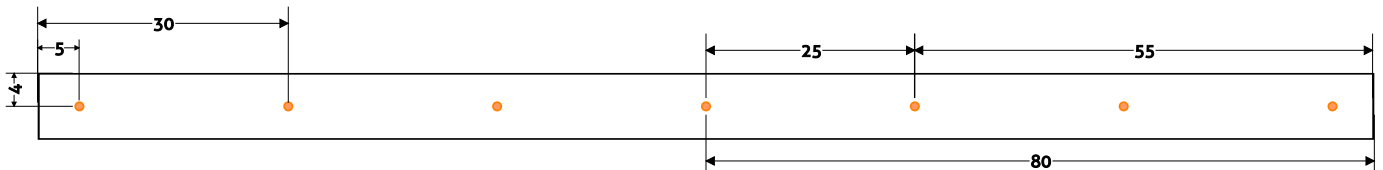

PLC-160081-7 Black 160cm ceiling base with 7 holes and incl. accessories*
 PLC-160082-7 White 160cm ceiling base with 7 holes and incl. accessories*

all measurements are in cm
 * incl. Wago and cable clamp connection kit

RECTANGULAR CEILING BASE 130x25x3,5cm



PLC-130251-0 Black 130cm ceiling base without holes and excl. accessories

PLC-130252-0 White 130cm ceiling base without holes and excl. accessories



Easy
to install

Ready
to connect

Metal
cable clamp

Powder
coated steel

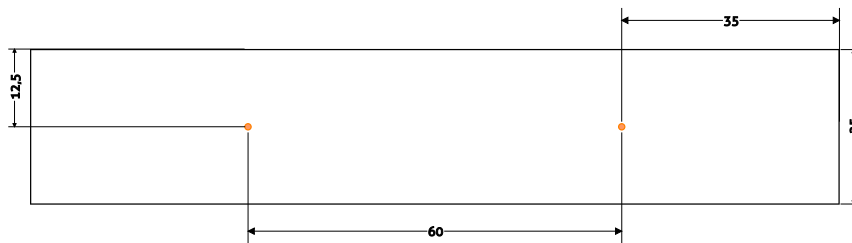

PLC-130251-2 Black 130cm ceiling base with 2 holes and incl. accessories*

PLC-130252-2 White 130cm ceiling base with 2 holes and incl. accessories*

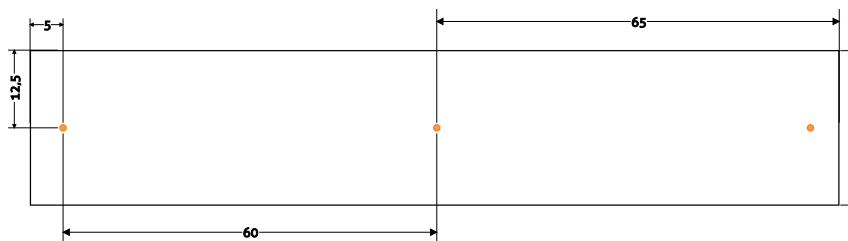

PLC-130251-3 Black 130cm ceiling base with 3 holes and incl. accessories*

PLC-130252-3 White 130cm ceiling base with 3 holes and incl. accessories*

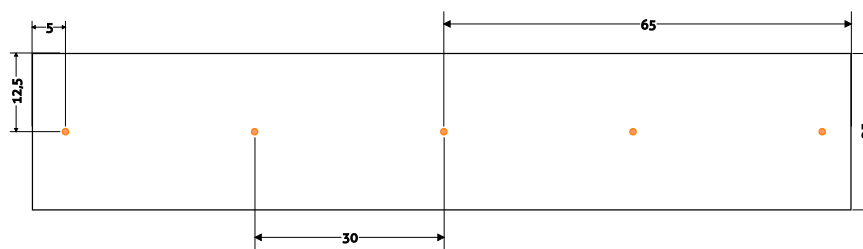

PLC-130251-5 Black 130cm ceiling base with 5 holes and incl. accessories*
PLC-130252-5 White 130cm ceiling base with 5 holes and incl. accessories*

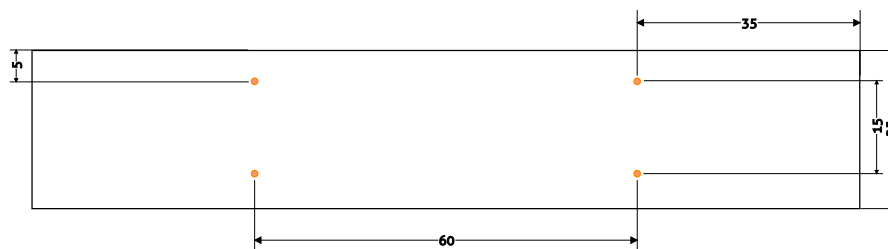

PLC-130251-22 Black 130cm ceiling base with 4 holes and incl. accessories*
PLC-130252-22 White 130cm ceiling base with 4 holes and incl. accessories*

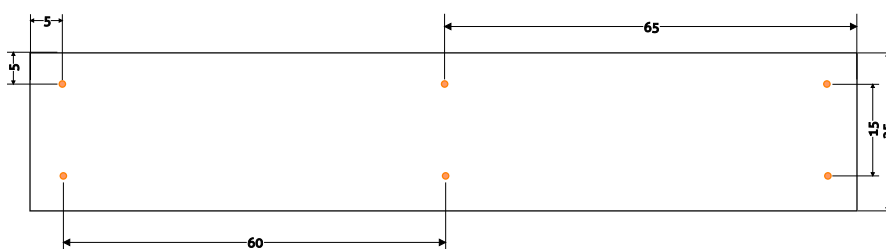

PLC-130251-33 Black 130cm ceiling base with 6 holes and incl. accessories*
PLC-130252-33 White 130cm ceiling base with 6 holes and incl. accessories*

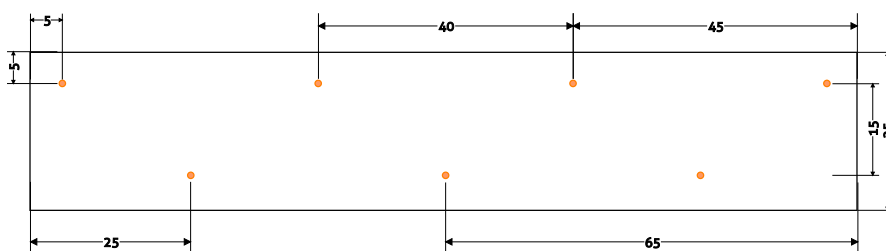

PLC-130251-34 Black 130cm ceiling base with 7 holes zigzag and incl. accessories*
PLC-130252-34 White 130cm ceiling base with 7 holes zigzag and incl. accessories*

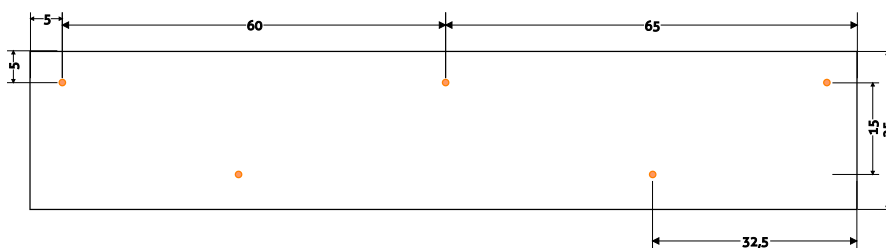

PLC-130251-23 Black 130cm ceiling base with 5 holes zigzag and incl. accessories*
PLC-130252-23 White 130cm ceiling base with 5 holes zigzag and incl. accessories*

RECTANGULAR CEILING BASE 160x25x3,5cm



PLC-160251-0 Black 160cm ceiling base without holes and excl. accessories
 PLC-160252-0 White 160cm ceiling base without holes and excl. accessories



Easy to install

Ready to connect

Metal cable clamp

Powder coated steel

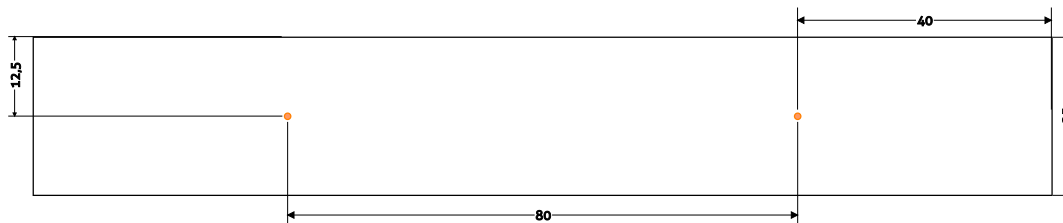

PLC-160251-2 Black 160cm ceiling base with 2 holes and incl. accessories*
 PLC-160252-2 White 160cm ceiling base with 2 holes and incl. accessories*

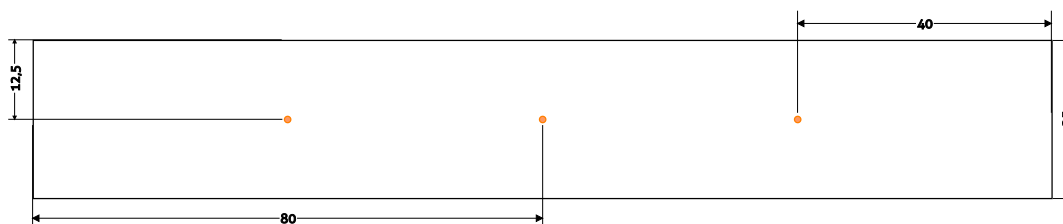

PLC-160251-3 Black 160cm ceiling base with 3 holes and incl. accessories*
 PLC-160252-3 White 160cm ceiling base with 3 holes and incl. accessories*

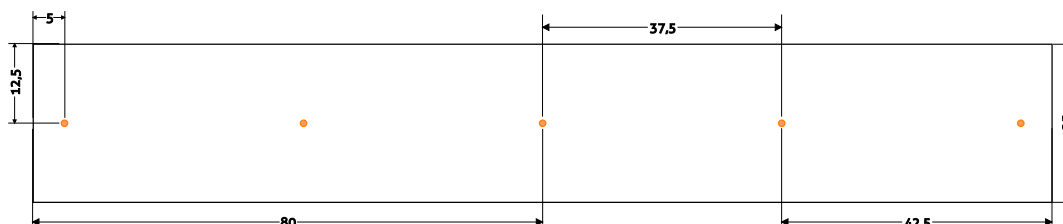

PLC-160251-5 Black 160cm ceiling base with 5 holes and incl. accessories*
 PLC-160252-5 White 160cm ceiling base with 5 holes and incl. accessories*

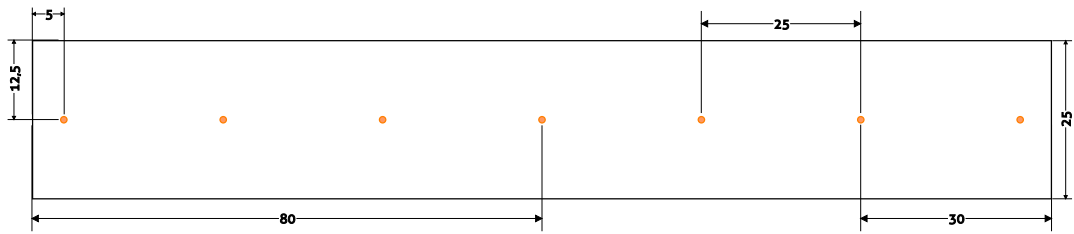

PLC-160251-7 Black 160cm ceiling base with 7 holes and incl. accessories*
PLC-160252-7 White 160cm ceiling base with 7 holes and incl. accessories*

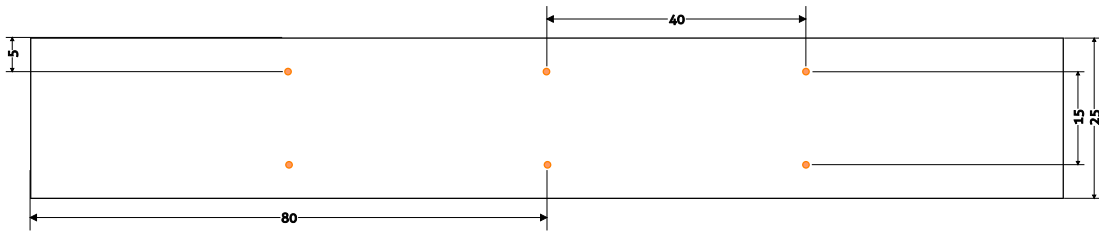

PLC-160251-33 Black 160cm ceiling base with 6 holes and incl. accessories*
PLC-160252-33 White 160cm ceiling base with 6 holes and incl. accessories*

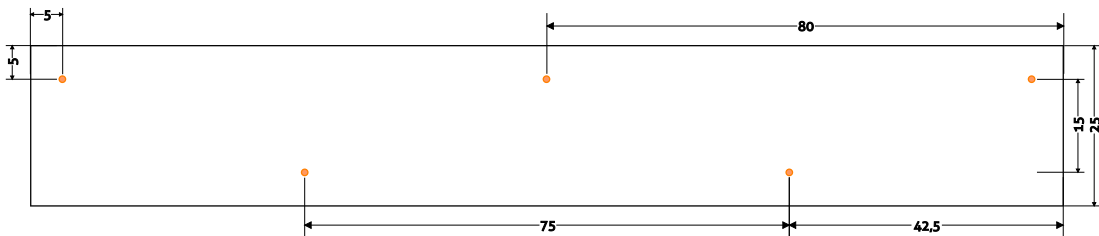

PLC-160251-23 Black 160cm ceiling base with 5 holes zigzag and incl. accessories*
PLC-160252-23 White 160cm ceiling base with 5 holes zigzag and incl. accessories*

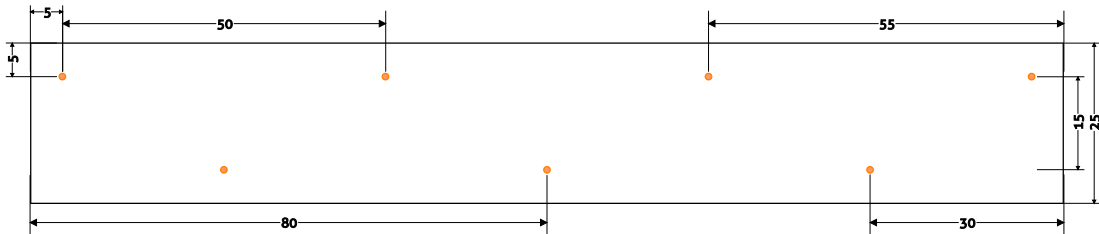

PLC-160251-34 Black 160cm ceiling base with 7 holes zigzag and incl. accessories*
PLC-160252-34 White 160cm ceiling base with 7 holes zigzag and incl. accessories*

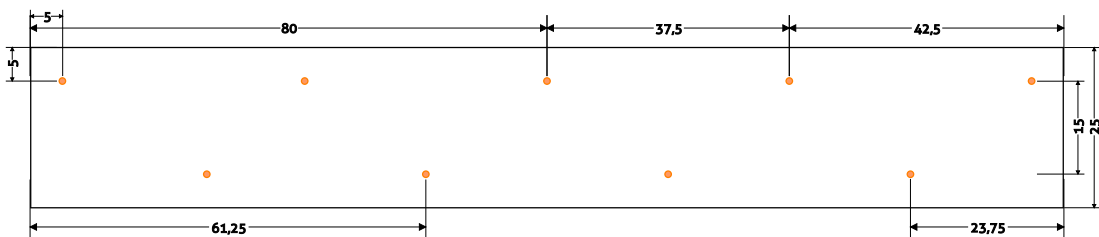

PLC-160251-45 Black 160cm ceiling base with 9 holes zigzag and incl. accessories*
PLC-160252-45 White 160cm ceiling base with 9 holes zigzag and incl. accessories*

ROUND CEILING BASE 50 x 3,5



PLC-050100-0 Black 50cm ceiling base without holes and excl. accessories
 PLC-050200-0 White 50cm ceiling base without holes and excl. accessories



Easy
to install

Metal
cable clamp

Powder
coated steel

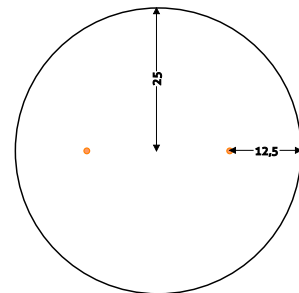
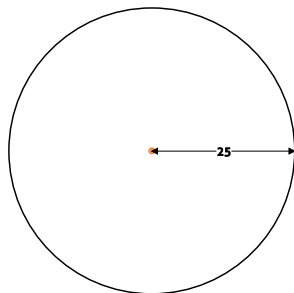

PLC-050101 Black 50cm ceiling base with 1 hole and incl. accessories*
 PLC-050201 White 50cm ceiling base with 1 holes and incl. accessories*

PLC-050102 Black 50cm ceiling base with 2 hole and incl. accessories*
 PLC-050202 White 50cm ceiling base with 2 holes and incl. accessories*

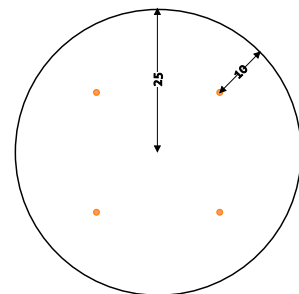
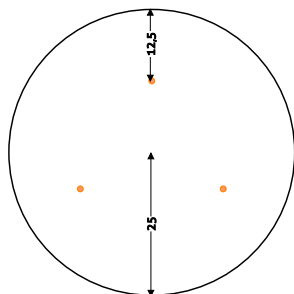

PLC-050103 Black 50cm ceiling base with 3 hole and incl. accessories*
 PLC-050203 White 50cm ceiling base with 3 holes and incl. accessories*

PLC-050104 Black 50cm ceiling base with 4 hole and incl. accessories*
 PLC-050204 White 50cm ceiling base with 4 holes and incl. accessories*

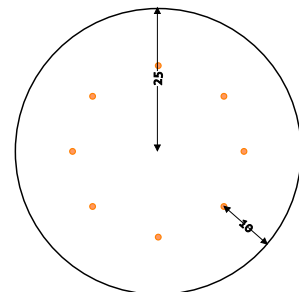
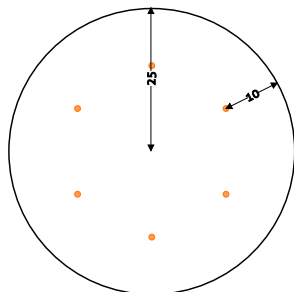

PLC-050106 Black 50cm ceiling base with 6 hole and incl. accessories*
 PLC-050206 White 50cm ceiling base with 6 holes and incl. accessories*

PLC-050108 Black 50cm ceiling base with 8 hole and incl. accessories*
 PLC-050208 White 50cm ceiling base with 8 holes and incl. accessories*

all measurements are in cm
 * incl. Wago and cable clamp connection kit

BIG CEILING BASE

ROUND: PLC-94312 12 hole base**

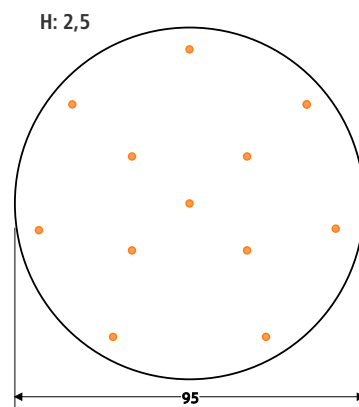

STONE: PLC-94508 8 hole base**

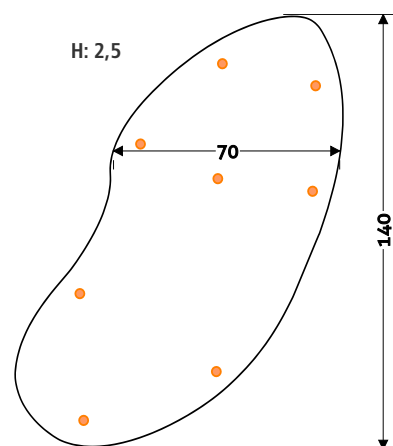

- * Powder coated metal
- * Installation ready (wago)

- * PLC-94312: 12.8kg
- * PLC-94508: 13.2kg

all measurements are in cm
* incl. Wago and cable clamp connection kit

MOXO PENDANTS E27

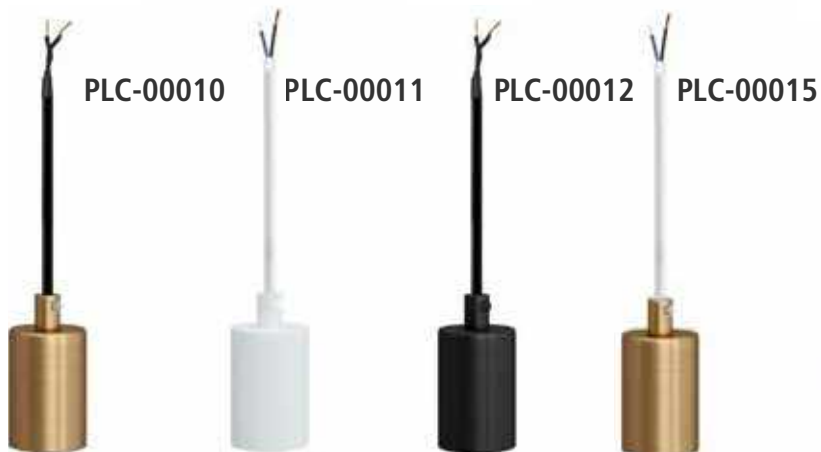

GOXO PENDANTS GU10 MINI



* incl. MINI GU10

BOXO PENDANTS TUBES S14D BLACK

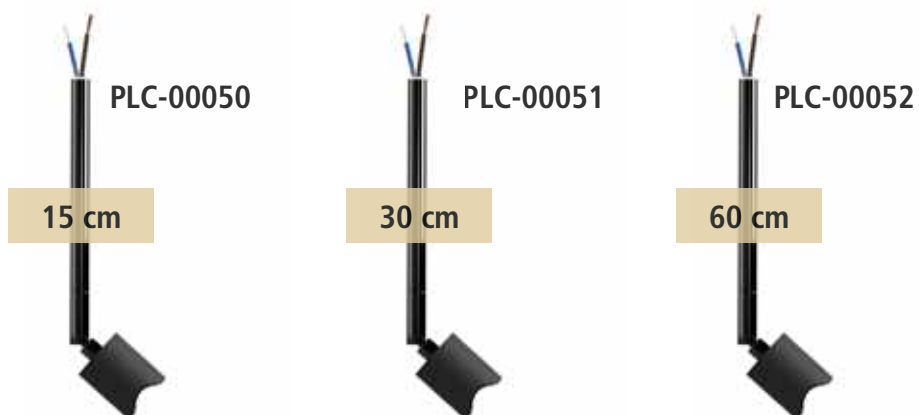

WOXO PENDANTS TUBES S14D WHITE

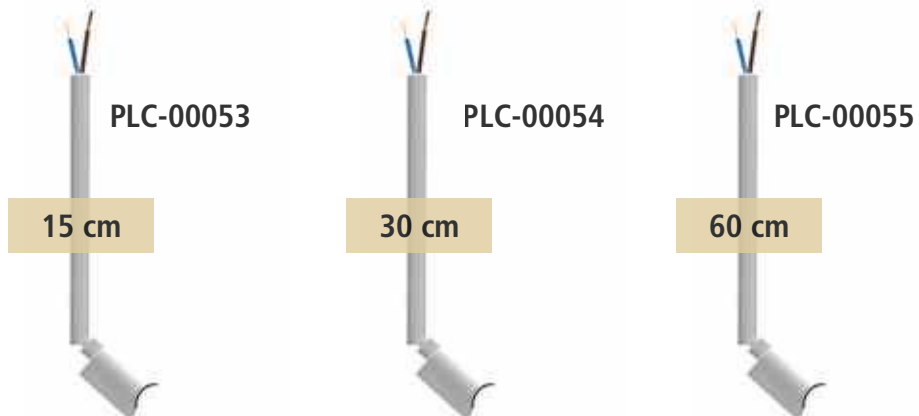

Art.No.	Description	Socket	Cable	max. Watt	Ø mm	Height mm
PLC-00010	GOXO Black cable pendant mat brass metal spot	E27	2m black	40W	44mm	76mm
PLC-00011	GOXO White cable pendant mat white metal spot	E27	2m white	40W	44mm	76mm
PLC-00012	GOXO Black cable pendant mat black metal spot	E27	2m black	40W	44mm	76mm
PLC-00015	GOXO White cable pendant mat brass metal spot	E27	2m white	40W	44mm	76mm
PLC-00001	MOXO Black cable pendant mat brass metal socket	Gu10	2m black	40W	42mm	62mm
PLC-00002	MOXO White cable pendant mat white metal socket	Gu10	2m white	40W	42mm	62mm
PLC-00003	MOXO Black cable pendant mat black metal socket	Gu10	2m black	40W	42mm	62mm
PLC-00050	BOXO Black 15cm Tube mat black rotatable S14D	S14D	15cm black	40W	47mm	55mm
PLC-00051	BOXO Black 30cm Tube mat black rotatable S14D	S14D	30cm black	40W	47mm	55mm
PLC-00052	BOXO Black 60cm Tube mat black rotatable S14D	S14D	60cm black	40W	47mm	55mm
PLC-00053	WOXO white 15cm Tube mat white rotatable S14D	S14D	15cm white	40W	47mm	55mm
PLC-00054	WOXO white 30cm Tube mat white rotatable S14D	S14D	30cm white	40W	47mm	55mm
PLC-00055	WOXO white 60cm Tube mat white rotatable S14D	S14D	60cm white	40W	47mm	55mm

SOXO THINK PAPER SOCKETS E27



PLC-00031



PLC-00032



PLC-00033

think paper

ROXO MARBLE PENDANTS E27



PLC-00020



PLC-00021

DOXO COMPOSITE PENDANTS E27

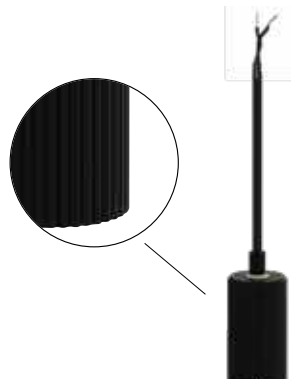

PLC-00040

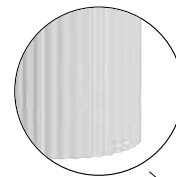

PLC-00041

Art.No.	Description	Socket	Cable	max. Watt	Ø mm	Height mm
PLC-00031	SOXO black cable pendant brown carton TP socket 01	E27	1,5m black	40W	90mm	110mm
PLC-00032	SOXO black cable pendant brown carton TP socket 02	E27	1,5m black	40W	90mm	130mm
PLC-00033	SOXO black cable pendant brown carton TP socket 03	E27	1,5m black	40W	90mm	160mm
PLC-00020	ROXO black cable pendant black marble socket	E27	2m black	40W	60mm	120mm
PLC-00021	ROXO white cable pendant white marble socket	E27	2m white	40W	60mm	120mm
PLC-00040	DOXO black cable pendant black 3D printed socket	E27	2m black	40W	52mm	90mm
PLC-00041	DOXO white cable pendant white 3D printed socket	E27	2m white	40W	52mm	90mm

BASE CONNECTORS



PLC-00070

Metal black
cable clamp (10 pcs)



PLC-00071

Metal white
cable clamp (10 pcs)

DECENTRALISER CEILING OR WALL HOOK



PLC-00085



PLC-00086

CEILING ROSE 83mm



PLC-00080



PLC-00081



PLC-00082

FLAT CEILING ROSE 126mm



PLC-00083



PLC-00084

AMARCORDS®

Italiaanse fabrikant met productie van hoogwaardige designverlichting in Milaan.

Amarcords is misschien niet het grootste bedrijf in omvang, maar blinkt uit in kwaliteit, afwerking en originaliteit. De vele kleurencombinaties van het Mono-fase railsysteem zorgen voor zeer eigentijdse creaties en heel veel mogelijkheden.

Fabricant italien produisant des luminaires design de haute qualité à Milan.

Amarcords n'est peut-être pas la plus grande société, mais elle excelle en termes de qualité, d'exécution et d'originalité. Les nombreuses combinaisons de couleurs du système de rails Monophasé permettent des créations très contemporaines et offrent énormément de possibilités.

An Italian manufacturer with production of high-quality design lighting in Milan.

Amarcords may not be the biggest company in size but it excels in quality, craftsmanship and originality.

The numerous colour combinations of the Monophase track system provide very contemporary creations and lots of possibilities.



ATD020-MF-xx*

Direct connector
with power supply
Maximum charge 16A

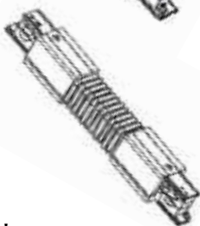

ATD079-MF-xx*

Flexible coupling for tracks
Radius of curvature 70° - 180°
Maximum charge 16A

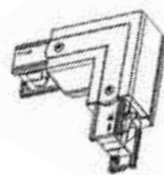

ATD090-MF-xx*

External L connector
with power supply for track
Maximum charge 16A

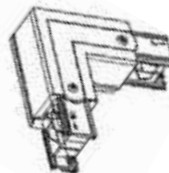

ATD021-MF-xx*

Internal L connector
with power supply for track
Maximum charge 16A

FINISHING*



OT
brass



BN
bronze



RM
pink
copper



BT
brutanium



TI
titanium



MONOPHASE TRACKS

Our Single Phase rail tracks are made out of aluminium and painted in the colour that matches perfect with the galvanised spots. Also all accessories have the possibility to have matching colours with the rail and spots. Don't forget to chose the finishing on the bottom of this page. The standard length of our rails are 2m.

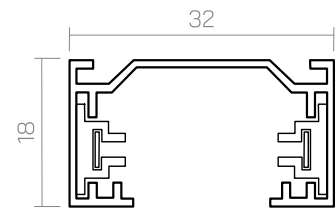

ATD010-MF-TI
Titanium



ATD010-MF-BN
Bronze



ATD010-MF-OT
Brass



ATD010-MF-BI
White



ATD010-MF-RM
Pink Copper



ATD010-MF-CO
Corten



ATD010-MF-CF
Metalgun



ATD010-MF-BR
Burnished



ATD010-MF-BT
Brutanium



ATD010-MF-NE
Black

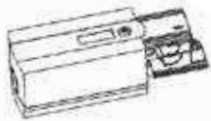

ATD074-MF-xx*
Left power supply for tracks
Maximum charge 16A

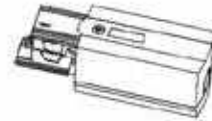

ATD075-MF-xx*
Right power supply for tracks
Maximum charge 16A

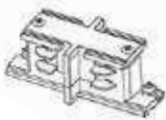

ATD077-MF-xx*
Blind conductive joint
for tracks



ATD076-MF-xx*
Terminal cover for tracks

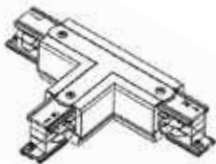

ATD091-MF-xx*
Left T connector
with power supply for track
Maximum charge 16A

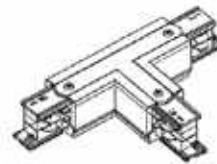

ATD022-MF-xx*
Right T connector
with power supply for track
Maximum charge 16A



ATD023-MF-xx*
X connector with power
supply for tracks
Maximum charge 16A



ATD028-MF-xx*
Suspension cable for tracks
complete with canopy

FINISHING*



SINGLE PHASE TRACK SPOTS - 230V - MINI GU10

Our Single Phase Track Spots are made out of aluminium, and depending on the finishing is powder coated or galvanised to obtain the most beautiful result. These products are 100% made and assembled in Italy. Each product is tested before leaving the production and every spot comes including a retrofit mini GU10 spot. The rail-connector has a matching colour with the tube of the spot.

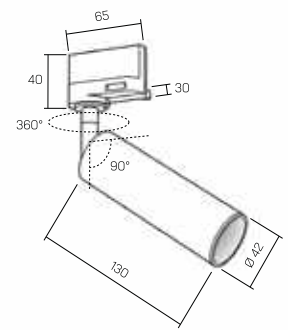

TO481-MF-OT
Brass



TO481-MF-BN
Bronze



TO481-MF-RM
Pink Copper



TO481-MF-TI
Titanium



TO481-MF-BT
Brutanium



TO481-MF-CF
Metalgun



TO481-MF-BI
White



TO481-MF-NE
Black



TO481-MF-CO
Corten



TO481-MF-BR
Burnished

SINGLE PHASE TRACK SPOTS - 230V - GU10

Our Single Phase Track Spots are made out of aluminium, and depending on the finishing is powder coated or galvanised to obtain the most beautiful result. These products are 100% made and assembled in Italy. Each product is tested before leaving the production and every spot comes including a retrofit GU10 spot. The rail-connector has a matching colour with the tube of the spot.

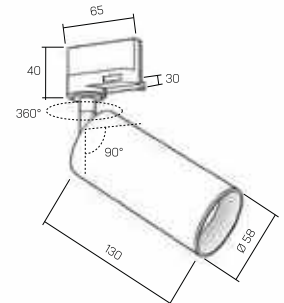

TO681-MF-OT
Brass



TO681-MF-BN
Bronze



TO681-MF-RM
Pink Copper



TO681-MF-TI
Titanium



TO681-MF-BT
Brutanium



TO681-MF-CF
Metalgun



TO681-MF-BI
White



TO681-MF-NE
Black



TO681-MF-CO
Corten



TO681-MF-BR
Burnished

TOBE - RECESSED - MINI GU10

Our TOBE Recessed Spots are made out of aluminium, and depending on the finishing is powder coated or galvanised to obtain the most beautiful result.

These products are 100% made and assembled in Italy. Each product is tested before leaving the production and every spot comes including a retrofit mini GU10 spot.

The built-in ceiling rose has a matching colour with the tube of the spot.

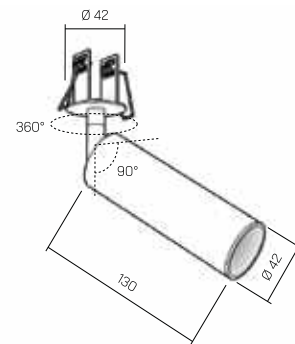

TO471-OT
Brass



TO471-BN
Bronze



TO471-RM
Pink Copper



TO471-TI
Titanium



TO471-BT
Brutanium



TO471-CF
Metalgun



TO471-BI
White



TO471-NE
Black



TO471-CO
Corten



TO471-BR
Burnished

TOBE - RECESSED - GU10

Our TOBE Recessed Spots are made out of aluminium, and depending on the finishing is powder coated or galvanised to obtain the most beautiful result.

These products are 100% made and assembled in Italy. Each product is tested before leaving the production and every spot comes including a retrofit GU10 spot.

The built-in ceiling rose has a matching colour with the tube of the spot.

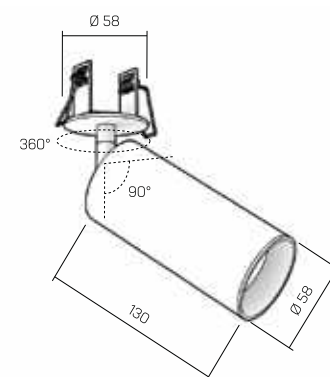

TO671-OT
Brass



TO671-BN
Bronze



TO671-RM
Pink Copper



TO671-TI
Titanium



TO671-BT
Brutanium



TO671-CF
Metalgun



TO671-BI
White



TO671-NE
Black



TO671-CO
Corten



TO671-BR
Burnished

TOBE - CEILING ROSE - 230V - MINI GU10

Our TOBE CEILING ROSE Recessed Spots are made out of aluminium, and depending on the finishing is powder coated or galvanised to obtain the most beautiful result.

These products are 100% made and assembled in Italy. Each product is tested before leaving the production and every spot comes including a retrofit mini GU10 spot. The ceiling rose with magnetic installation has a matching colour with the tube of the spot.

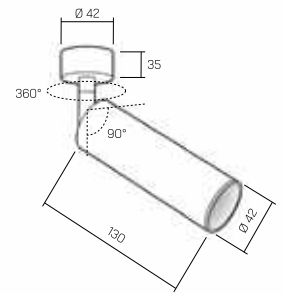

TO411-OT
Brass



TO411-BN
Bronze



TO411-RM
Pink Copper



TO411-TI
Titanium



TO411-BT
Brutanium



TO411-CF
Metalgun



TO411-BI
White



TO411-NE
Black



TO411-CO
Corten



TO411-BR
Burnished

TOBE - PLAFONE - CEILING ROSE - 230V - GU10

Our TOBE CEILING ROSE Recessed Spots are made out of aluminium, and depending on the finishing is powder coated or galvanised to obtain the most beautiful result.

These products are 100% made and assembled in Italy. Each product is tested before leaving the production and every spot comes including a retrofit GU10 spot. The ceiling rose with magnetic installation has a matching colour with the tube of the spot.

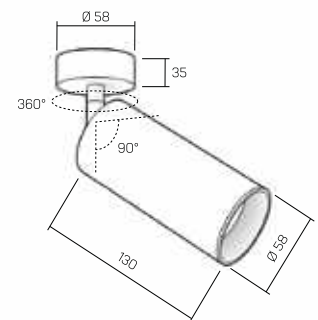

TO611-OT
Brass



TO611-BN
Bronze



TO611-RM
Pink Copper



TO611-TI
Titanium



TO611-BT
Brutanium



TO611-CF
Metalgun



TO611-BI
White



TO611-NE
Black



TO611-CO
Corten



TO611-BR
Burnished



TOBE - ORGANO CEILING LIGHT - 230V - GU10

Our TOBE ORGANO Ceiling Spots are made out of aluminium, and depending on the finishing is powder coated or galvanised to obtain the most beautiful result. These products are 100% made and assembled in Italy. Each product is tested before leaving the production and every spot comes including a retrofit GU10 spot. The ORGANO Tube is very easy to install because of magnetic installation. Matching finishing are found on the bottom of this page.



Magnetic

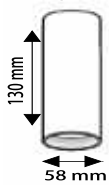

CICCIO 13
h 13 cm

TP661-xx*



Magnetic



CICCIO 21
h 21cm

TP662-xx*



Magnetic



CICCIO 34
h 34cm

TP663-xx*



Magnetic



CICCIO 55
h 55cm

TP665xx*



Magnetic



CICCIO 89
h 89cm
TP668-xx*

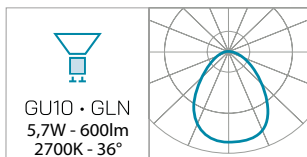

FINISHING*



OT
brass



BN
bronze



CF
metalgun



NE
black



RM
pink
copper



BT
brutanium



TI
titanium



BI
white



CO
corten



BR
burnished



FINISHING*



OT
brass



BN
bronze



RM
copper



BT
brutanium



TI
titanium



CF
metalgun

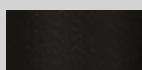

NE
black



****B**
white



CO
corten



BR
burnished

**white cable

TOBE ORGANO PENDANT LIGHTS - GU10 – 230V

Our TOBE ORGANO PENDANT LIGHTS are made out of aluminium, and depending on the finishing it will be powder coated or galvanised to obtain the most beautiful result.

These products are 100% made and assembled in Italy. Each product is tested before leaving the production and every tube comes including a retrofit GU10 spot.

The ORGANO pendants have 3 different possible ceiling fixations: single phase rail connector, recessed- and standard 6cm ceiling rose.

After choosing the right size and ceiling connection, please add the wanted finishing to the item number, we have 10 different finishings.

TR681-*



TR682-*



TR683-*



TR685-*



TR688-*



SINGLE PHASE CONNECTOR

TR671-*



TR672-*



TR673-*



TR675-*



TR678-*



RECESSED

TR611-*



TR612-*



TR613-*



TR615-*



TR618-*



CEILING ROSE

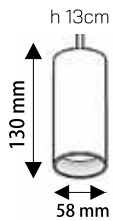

TRACK

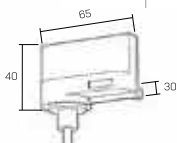

RECESSED

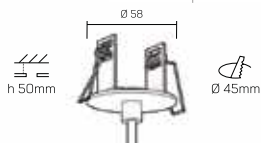

CEILING ROSE

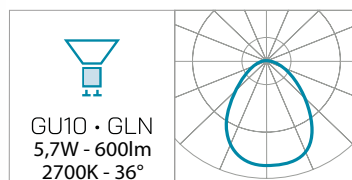
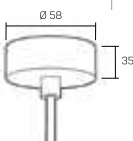



FINISHING*



OT
brass



BN
brnze



RM
copper



BT
brutanium



TI
titanium



CF
metalgun

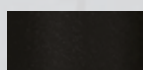

NE
black

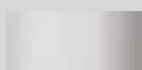

BT
white



CO
corten



BR
burnished

**white cable

TOBE CICCIO E27 PENDANT LIGHTS – E27 – 230V

Our TOBE ORGANO Ceiling Spots are made out of aluminium, and depending on the finishing it will be powder coated or galvanised to obtain the most beautiful result. These products are 100% made and assembled in Italy. Each product is tested before leaving the production and every tube has an E27 socket.

The ORGANO pendants have 3 different possible ceiling fixations: single phase rail connector, recessed- and standard 6cm ceiling rose. After choosing the right size and ceiling connection, please add the wanted finishing to the item number, we have 10 different finishings.

TR781-*



TR782-*



TR783-*



TR785-*



TR788-*



SINGLE PHASE CONNECTOR

TR771-*



TR772-*



TR773-*



TR775-*



TR778-*



RECESSED

TR711-*



TR712-*



TR713-*



TR715-*



TR718-*



CEILING ROSE

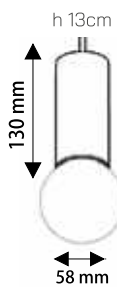

TRACK

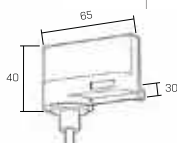

RECESSED



CEILING ROSE

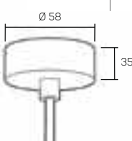

h 21cm



h 34cm



h 55cm



h 89cm





QAMAR – MB200

IP54 Battery Powered Table Lamp.

Touch dimmable metal table lamp. Double light source, an indirect lateral table washer and a central vertical one to illuminate a bottle and exploit the natural element of water as a diffusion of light. The base is available in 10 different finishings and each Qamar can be delivered with a beautiful water bottle that is made in Germany.

This product already won an innovation award and is off course made and assembled in Italy. Each Qamar has an autonomy of minimum 8h and is fully rechargeable with a mini-usb connector cable that is delivered with the lamp.

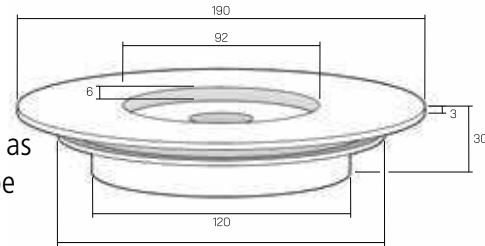

OPTIONAL
EU MADE
GLASS WATER BOTTLE
MB2000-BA



MB200-OT



MB200-BN



MB200-RM



MB200-TI



MB200-BT



MB200-CF



MB200-BI



MB200-NE



MB200-CO



MB200-BR

CHECK OUR COMPLETE CATALOGUE OF AMARCORDS

WWW.QUALITY-LEDS.COM





Deze Belgische ontwerper met eigen productie in de Belgische Ardennen is echt het ontdekken waard. Niet alleen worden deze volledig houten pareltjes gemaakt zonder lijm of schroeven, ze vullen ruimtes en doen monden openvallen. Om het helemaal duurzaam en ecologisch te maken wordt er voor elk geproduceerd armatuur een boom gepland, kan het nog beter?

Ce designer belge dont la production est située dans les Ardennes, mérite vraiment d'être découvert. Non seulement ces bijoux en bois sont fabriqués sans colle ni vis, mais ils remplissent les espaces et ne vous laissent pas indifférents... Pour que ce soit totalement durable et écologique, un arbre est planté pour chaque luminaire produit, peut-on faire mieux ?

This Belgian designer with its own production in the Belgian Ardennes is really worth discovering. Not only are these all-wood jewels made without glue or any screws, they fill spaces and make mouths drop open. To make it completely sustainable and ecological, a tree is planted for each luminaire produced, can it get any better?



Double Maxime natural



Art Maker

Art.No.

AM-DM100-CH
AM-DM140-CH
AM-DM200-CH

Description

DOUBLE MAXIME CHÊNE NATURE SMALL
DOUBLE MAXIME CHÊNE NATURE MEDIUM
DOUBLE MAXIME CHÊNE NATURE BIG

Socket

E27
E27
E27

Cable

2m black cable
2m black cable
2m black cable

Ø cm

100
140
200

H

18 cm
23 cm
32 cm

Weight

1,5 kg
1,75 kg
2 kg

100% wood

OAK
OAK
OAK

Double Maxime black



Art Maker

Art.No.

AM-DM100-NR
AM-DM140-NR
AM-DM200-NR

Description

DOUBLE MAXIME HÊTRE NOIR SMALL
DOUBLE MAXIME HÊTRE NOIR MEDIUM
DOUBLE MAXIME HÊTRE NOIRE BIG

Socket

E27
E27
E27

Cable

2m black cable
2m black cable
2m black cable

Ø cm

100
140
200

H

18 cm
23 cm
32 cm

Weight

1,5 kg
1,75 kg
2 kg

100% wood

BEECH
BEECH
BEECH



Florentin natural



Art.No.

AM-FL120-CH
AM-FL140-CH
AM-FL200-CH

Description

FLORENTIN CHÊNE NATURE SMALL
FLORENTIN CHÊNE NATURE MEDIUM
FLORENTIN CHÊNE NATURE BIG

Socket

E27
E27
E27

Cable

2m black cable
2m black cable
2m black cable

Ø cm

100
140
200

H

18 cm
20 cm
29 cm

Weight

1,5 kg
1,75 kg
2 kg

100% wood

OAK
OAK
OAK

Florentin black



Art.No.

AM-FL120-NR
AM-FL140-NR
AM-FL200-NR

Description

FLORENTIN HÊTRE NOIR SMALL
FLORENTIN HÊTRE NOIR MEDIUM
FLORENTIN HÊTRE NOIRE BIG

Socket

E27
E27
E27

Cable

2m black cable
2m black cable
2m black cable

Ø cm

100
140
200

H

18 cm
20 cm
29 cm

Weight

1,5 kg
1,75 kg
2 kg

100% wood

BEECH
BEECH
BEECH



Maxime natural

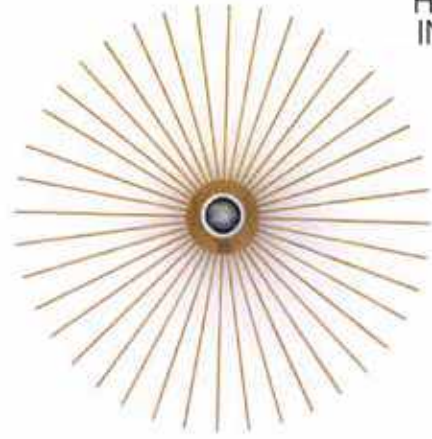

Art.No.

AM-MA40-CH
AM-MA60-CH

Description

MAXIME CHÊNE NATURE SMALL
MAXIME CHÊNE NATURE BIG

Socket

E27
E27

Ø cm

40
60

H

15 cm
15 cm

Weight

1 kg
1,5 kg

100% wood

OAK
OAK

Maxime black

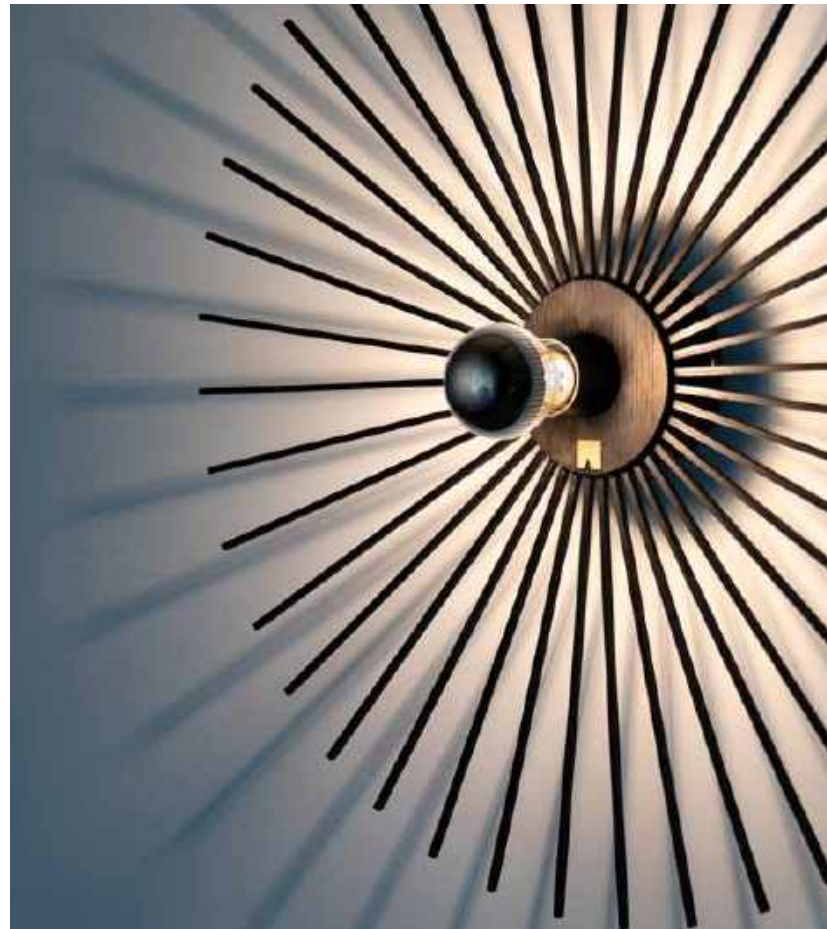
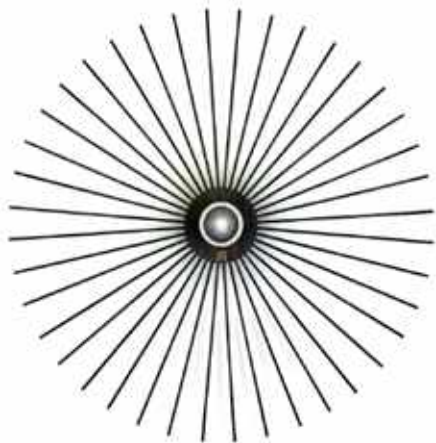

Art.No.

AM-MA40-NR
AM-MA60-NR

Description

MAXIME HÊTRE NOIR SMALL
MAXIME HÊTRE NOIR BIG

Socket

E27
E27

Ø cm

40
60

H

15 cm
15 cm

Weight

1 kg
1,5 kg

100% wood

BEECH
BEECH

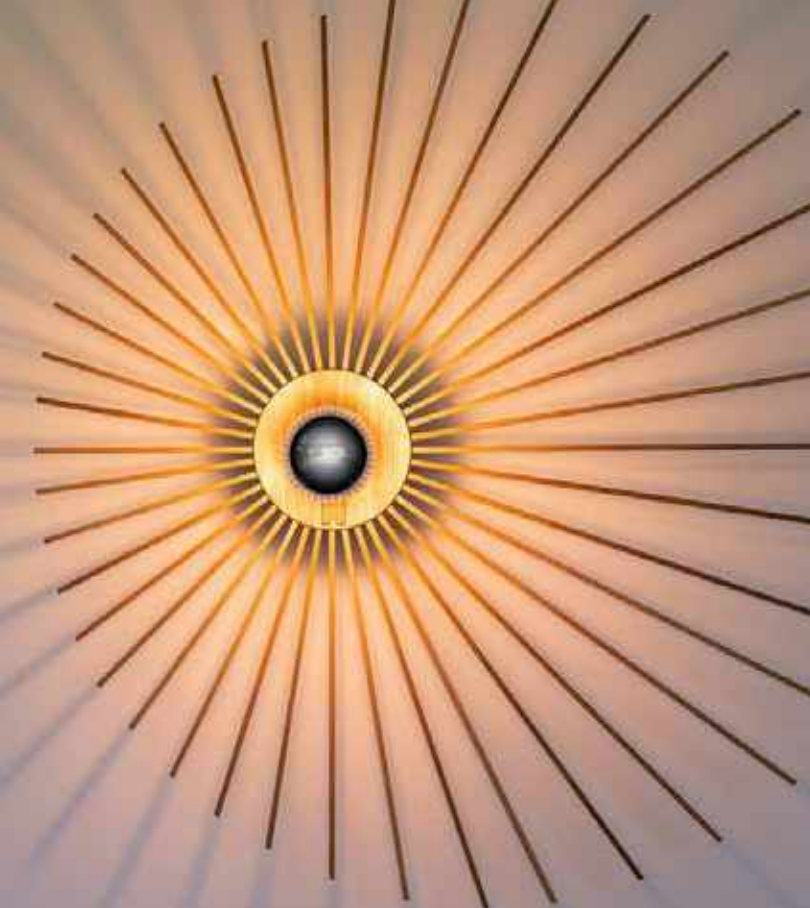

Maxime asymmetric natural  **HANDMADE IN BELGIUM**

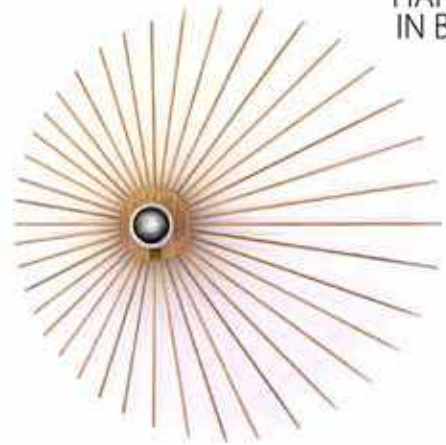

Art.No.	Description
AM-ME40-CH	MAXIME ASSYMETRIC CHÊNE NATURE SMALL
AM-ME60-CH	MAXIME ASSYMETRIC CHÊNE NATURE BIG

Socket	Ø cm	H	Weight	100% wood
E27	40	15 cm	1 kg	OAK
E27	60	15 cm	1,5 kg	OAK

Maxime asymmetric black  **HANDMADE IN BELGIUM**

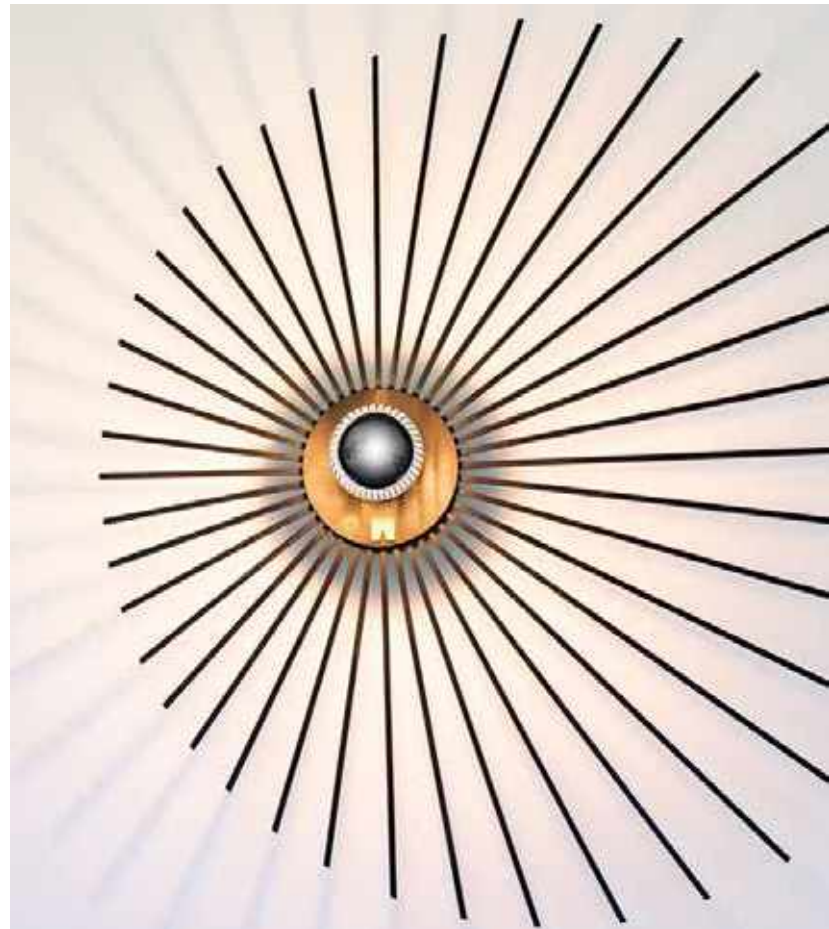
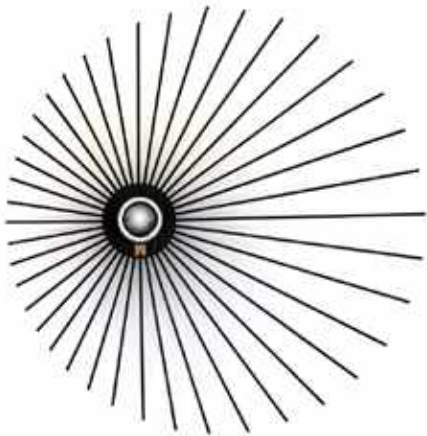

Art.No.	Description
AM-ME40-NR	MAXIME ASSYMETRIC HÊTRE NOIR SMALL
AM-ME60-NR	MAXIME ASSYMETRIC HÊTRE NOIR BIG

Socket	Ø cm	H	Weight	100% wood
E27	40	15 cm	1 kg	BEECH
E27	60	15 cm	1,5 kg	BEECH



Martin natural & black



Art.No.

AM-MT20-CH
AM-MT20-NR

Description

MARTIN CHÊNE NATURAL
MARTIN HÊTRE NOIRE

Socket

E27
E27

Cable

2m black cable
2m black cable

Ø cm

8
8

H

20 cm
20 cm

Weight

0,5 kg
0,5 kg

100% wood

OAK
BEECH

Martine natural & black



Art.No.

AM-MT21-CH
AM-MT21-NR

Description

MARTINE CHÊNE NATURAL
MARTINE HÊTRE NOIRE

Socket

E27
E27

Cable

2m black cable
2m black cable

Ø cm

8
8

H

20 cm
20 cm

Weight

0,5 kg
0,5 kg

100% wood

OAK
BEECH



think paper

 HANDMADE
IN THE NETHERLANDS



COMPANY

Think Paper ontwierp The Dutch Tulip in opdracht van de Rijksdienst voor Ondernemend Nederland. Dit paviljoen werd gepresenteerd op het WorldSkills event in Leipzig en was volledig vervaardigd uit karton. Maar liefst 200.000 bezoekers bezochten The Dutch Tulip. Het spectaculaire concept wordt nu vertaald naar exclusieve producten, geïnspireerd door passie voor design en ongewone duurzame materialen. Tot op de dag van vandaag heeft Think Paper een uniek portfolio gecreëerd met exclusieve producten en op maat gemaakte objecten voor zowel de zakelijke én de particuliere markt, nationaal en internationaal.

Think Paper a conçu The Dutch Tulip pour le compte de l'agence néerlandaise pour les entreprises. Ce pavillon a été présenté à l'événement WorldSkills à Leipzig et était fabriqué entièrement en carton. Pas moins de 200 000 visiteurs ont visité The Dutch Tulip. Ce concept spectaculaire est désormais proposé en produits exclusifs, inspirés par une passion pour le design et les matériaux durables et peu utilisés jusqu'alors à cet effet. Think Paper a créé une gamme unique comprenant des produits exclusifs, des objets personnalisés pour le marché, les entreprises nationales et internationales.

Think Paper designed The Dutch Tulip on behalf of the Rijksdienst voor Ondernemend Nederland. This pavilion was presented at the WorldSkills event in Leipzig and was entirely made of cardboard. No fewer than 200,000 visitors visited The Dutch Tulip. The spectacular concept is now being converted into exclusive products, inspired by passion for design and unusual sustainable materials. To this day today, Think Paper has created a unique portfolio of exclusive products and tailor-made objects for both the commercial and private markets, nationally and internationally.

KRAFTS COLLECTION

Het woord KRAFTS staat voor Kraft (met een K), de stevige papiersoort die wordt gebruikt als toplaag. En Craft (met een C), wat betekend professioneel met de hand vervaardigd. De KRAFTS zijn zo ontworpen om ieder interieur te complementeren met hun warme, sfeervolle en elegante uitstraling. Elk van de KRAFTS wordt milieuvriendelijk, maatschappelijk verantwoord en vakkundig geassembleerd in Nederland. Door de combinatie van de modernste technieken en het verfijndste handwerk is het mogelijk om een bijzonder patroon te creëren welk een uniek effect geeft aan elke ruimte, omgeving en gelegenheid.

Elk ontwerp heeft zijn eigen identiteit. Welke stijl je ook hebt, je zult altijd een KRAFT vinden die bij je past.

KRAFTS avec un K signifie qu'une couche de papier renforcé est utilisée pour la couche supérieure. Craft avec C mentionne l'aspect manuel et professionnel de la fabrication. Les KRAFTS sont écologiques, sur mesure, professionnels, éco-responsables et fabriqués aux Pays-Bas. Grâce à la combinaison d'une technologie à la pointe et d'un travail soigné, il est possible de créer un motif spécial avec effet unique pour chaque espace ou environnement.

Chaque design a sa propre identité:
il y a toujours KRAFT qui convient à votre style.

The word KRAFTS stands for Kraft (with a K), the firm type of paper used as the top layer. And Craft (with a C), which means professionally handmade. KRAFTS are designed to bring a touch of warmth to any interior. Each of the KRAFTS is environmentally friendly, socially inclusive and professionally assembled in the Netherlands. Through the combination of state-of-the-art techniques and the finest craftsmanship it is possible to create a special pattern which will bring a unique effect to any space, environment and occasion. Each design has its own identity. Whatever style you have, you will always find a KRAFT that suits you.



think paper

KRAFTS NUANCED SERIES

De genuanceerde Krafts modellen zijn de ware klassiekers binnen de collectie. Het patroon lijkt misschien volledig willekeurig. Echter is elk patroon zorgvuldig door Think Paper samengesteld en is elk specifiek model telkens weer identiek. Het genuanceerde patroon varieert tussen open en gesloten, licht en donker. De modellen in deze collectie verlichten hun omgeving 360 graden en zorgen voor een tijdloze uitstraling. Het verfijnde patroon zorgt voor een adembenemend uniek licht effect in elke ruimte of omgeving.

Les modèles Krafts nuancés sont les véritables classiques de la collection. Le motif peut sembler complètement aléatoire. En réalité, chaque modèle est soigneusement élaboré par Think Paper.



Art.No.	Description	Socket	Cable	max. Watt	Ø mm	Height mm	Pck
TP-DAZ-290	DANDY 290 nuanced	E27	1,5m Textile Cable	40 W	290	150	1
TP-DAZ-440	DANDY 440 nuanced	E27	1,5m Textile Cable	40 W	440	230	1
TP-DAZ-640	DANDY 640 nuanced	E27	1,5m Textile Cable	40 W	640	330	1
TP-DAZ-890	DANDY 890 nuanced	E27	1,5m Textile Cable	40 W	890	460	1



KRAFTS NUANCED SERIES

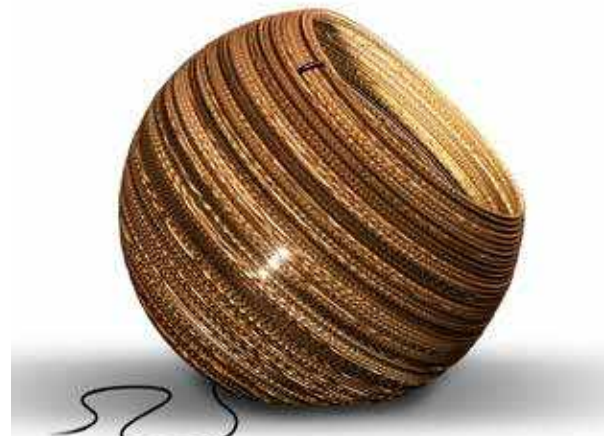
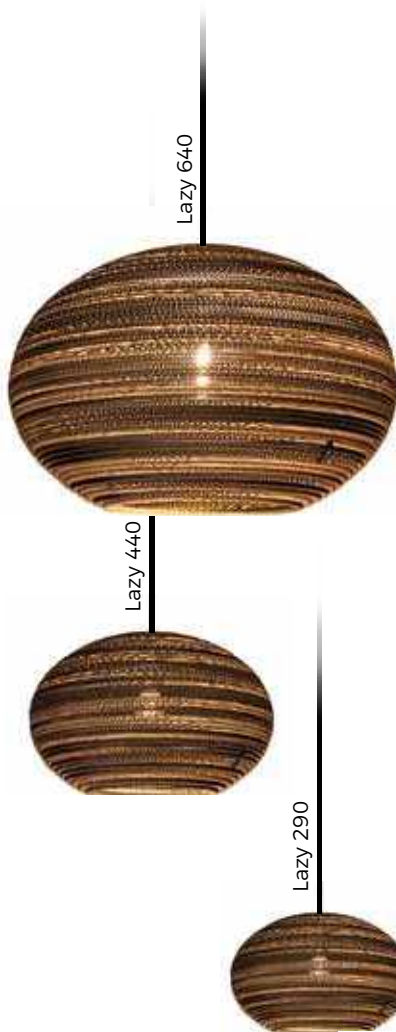

Globe 640



Globe 440



Globe 290

Art.No.	Description	Socket	Cable	max. Watt	Ø mm	Height mm	Pck
TP-LAZ-290	LAZY 290 nuanced	E27	1,5m Textile Cable	40 W	290	180	1
TP-LAZ-440	LAZY 440 nuanced	E27	1,5m Textile Cable	40 W	440	280	1
TP-LAZ-640	LAZY 640 nuanced	E27	1,5m Textile Cable	40 W	640	410	1
TP-GLZ-290	GLOBE 290 nuanced	E27	1,5m Textile Cable	40 W	290	270	1
TP-GLZ-440	GLOBE 440 nuanced	E27	1,5m Textile Cable	40 W	440	410	1
TP-GLZ-640	GLOBE 640 nuanced	E27	1,5m Textile Cable	40 W	640	590	1





Oval 440



Oval 540



Oval 640

Art.No.	Description	Socket	Cable	max. Watt	Ø mm	Height mm	Pck
TP-OVAL-440	OVAL 440 nuanced	E27	1,5m Textile Cable	40 W	440/340	200	1
TP-OVAL-540	OVAL 540 nuanced	E27	1,5m Textile Cable	40 W	540/420	230	1
TP-OVAL-640	OVAL 640 nuanced	E27	1,5m Textile Cable	40 W	640/500	260	1

KRAFTS SPIRAL SERIES

De spiraal gevormde Krafts modellen zijn uniek. Bekwaam handwerk en kwaliteit zorgen voor elegantie en verfijning dat je ziet schitteren in elk ontwerp. Het patroon is zorgvuldig door Think Paper samengesteld en is in elk specifiek model telkens weer identiek. De spiraalvormige golven creëren een contrasterend effect dat zorgt voor een open en gesloten structuur en varieert tussen licht en donker. De modellen hebben een ongekend elegant charisma en hebben vanuit iedere hoek bekeken een andere adembenemende uitstraling

Les modèles Krafts en forme de spirales sont uniques. Le savoir-faire et la qualité garantissent l'élégance et la sophistication que vous retrouvez dans chaque design. Le motif a soigneusement été mis au point par Think Paper ; il est identique dans tous les modèles. Le mouvement en spirales crée un effet contrastant qui assure une structure ouverte et fermée, qui alterne entre lumière et obscurité. Les modèles ont un charme élégant sans précédent, un look inégalable sous tous les angles.

The spiral-shaped Krafts models are unique. Skilled craftsmanship and quality ensure elegance and sophistication that you see shining in every design. The pattern has been carefully composed by Think Paper and is identical in each specific model identical every time. The spiral waves create a contrasting effect that creates an open and closed structure and varies between light and dark. The models have an unprecedented elegant charisma and when looked at a different breathtaking effect.



Art.No.	Description	Socket	Cable	max. Watt	Ø mm	Height mm	Pck
TP-CLZ-290	CLASSY 290 spiral	E27	1,5m Textile Cable	40 W	290	180	1
TP-CLZ-440	CLASSY 440 spiral	E27	1,5m Textile Cable	40 W	440	280	1
TP-CLZ-640	CLASSY 640 spiral	E27	1,5m Textile Cable	40 W	640	410	1



KRAFTS SPIRAL SERIES



Art.No.	Description	Socket	Cable	max. Watt	Ø mm	Height mm	Pck
TP-JAZ-440	JAZZY 440 spiral	E27	1,5m Textile Cable	40 W	440	170	1
TP-JAZ-640	JAZZY 640 spiral	E27	1,5m Textile Cable	40 W	640	250	1
TP-JAZ-890	JAZZY 890 spiral	E27	1,5m Textile Cable	40 W	890	350	1



Art.No.

TP-SKZ-210
TP-SKZ-290

Description

SKINNY 210 spiral
SKINNY 290 spiral

Socket

2 x E27
2 x E27

Cable

1,5m Textile Cable
1,5m Textile Cable

max. Watt

40 W
40 W

Ø mm

210
290

Height mm

1100
1500

Pck

1
1



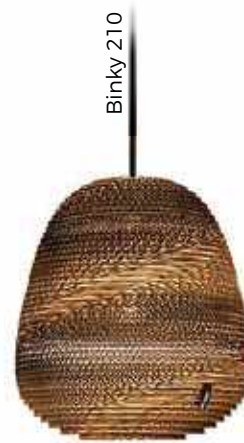

Art.No.	Description	Socket	Cable	max. Watt	Ø mm	Height mm	Pck
TP-BIZ-210	BINKY 210 spiral	E27	1,5m Textile Cable	40 W	210	230	1
TP-BIZ-290	BINKY 290 spiral	E27	1,5m Textile Cable	40 W	290	310	1





KRAFTS SPIRAL SERIES



Art.No.	Description	Socket	Cable	max. Watt	Ø mm	Height mm	Pck
TP-BAZ-290	BAGGY 290 spiral	E27	1,5m Textile Cable	40 W	290	430	1
TP-BAZ-440	BAGGY 440 spiral	E27	1,5m Textile Cable	40 W	440	660	1
TP-BAZ-640	BAGGY 640 spiral	E27	1,5m Textile Cable	40 W	640	950	1

SOCKETS



Art.No.	Description	Socket	Cable	max. Watt	Ø mm	Height mm	Pck
TP-S001-NPL	Socket01 Nuanced - Pendant lamp	E27	1,5m Textile Cable	40 W	90	110	1
TP-S002-NPL	Socket02 Nuanced - Pendant lamp	E27	1,5m Textile Cable	40 W	90	130	1
TP-S003-NPL	Socket03 Nuanced - Pendant lamp	E27	1,5m Textile Cable	40 W	90	160	1

MEET
BLOS™
OUTDOOR

BY

PERLUCI

ANDON
TORO
SHINTAKU



ENHANCE
YOUR
OUTDOOR
SPACE

SHINTAKU

Introducing **BLOS™ SHINTAKU**: inspired by the grace of Japanese lanterns, this Cylindrical-shaped fixture emanates a gentle radiance, bringing tranquility to your outdoor setting.

BLOS™

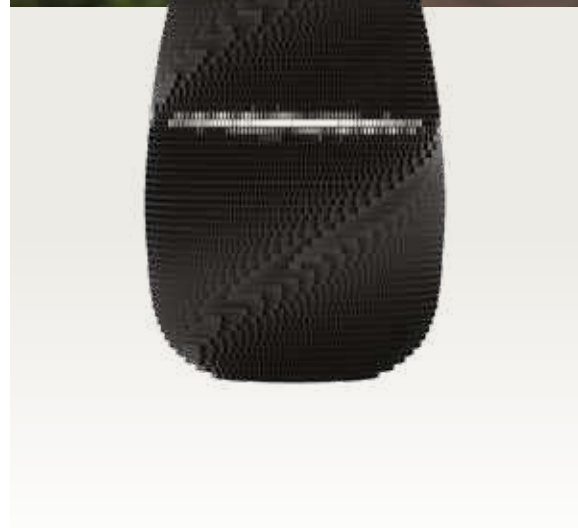

BLOS™

Protection	: IP65*
Rated voltage	: 250 Vac
Class	: II
Lamp holder	: E27
Cable	: Outdoor UV textile cable
Cable colours	: ● ● ● ● ● ●
Shade colours	: ● ●
Light bulb	: Not included
Connection	: Soft ceiling rose silicone / Power plug
Cable length	: 3 m CR (ceiling rose) / 5 m PP (power plug)
Material	: Recycled polypropylene

SIZING

SHINTAKU is available in three sizes:
Small, Medium and Large.

S

Width	270 mm	Height	422 mm
-------	--------	--------	--------



M

Width	405 mm	Height	653mm
-------	--------	--------	-------



L

Width	540 mm	Height	816 mm
-------	--------	--------	--------

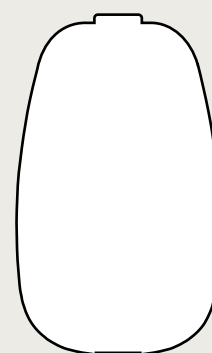

 **HANDMADE**
IN THE NETHERLANDS

* The lamp holder is designed for glass LED light bulbs only and has been tested as compatible with the A60, ST64, G95 and G125 bulb shapes that guarantee rating of IP65 protection.

ANDON

Introducing **BLOS™ ANDON**: uniquely designed with a box-shaped elegance, inspired by Japanese lanterns. This fixture casts a warm glow, bringing serenity to your outdoor space.

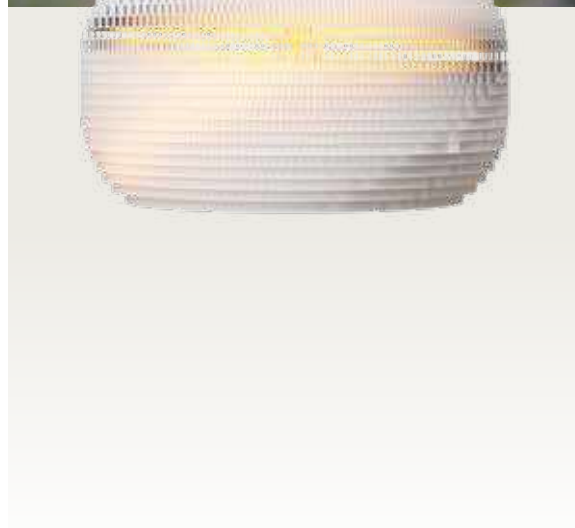
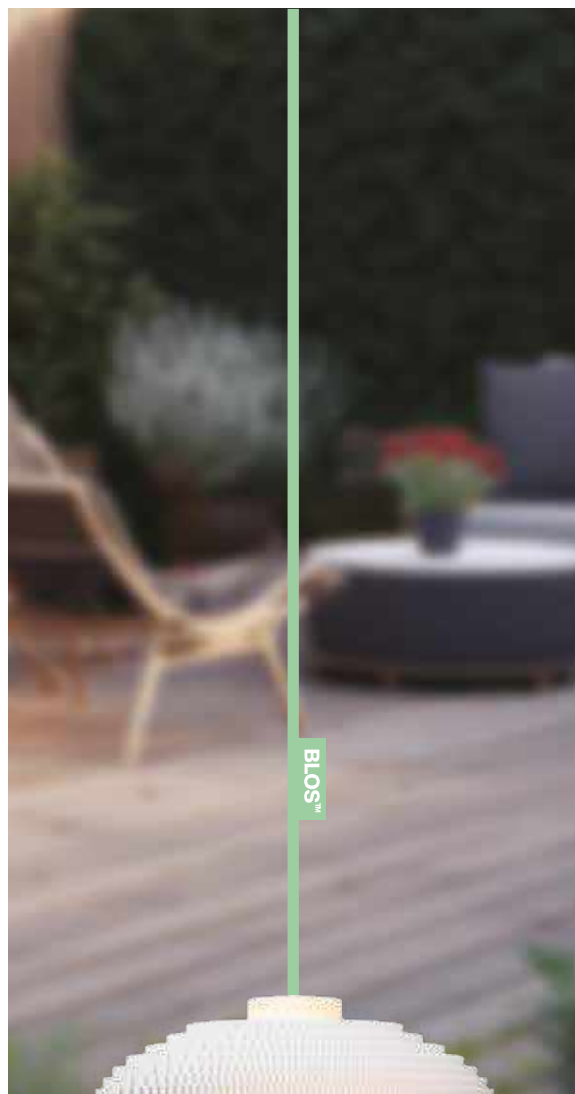

BLOS™

Protection	: IP65*
Rated voltage	: 250 Vac
Class	: II
Lamp holder	: E27
Cable	: Outdoor UV textile cable
Cable colours	: ● ● ● ● ●
Shade colours	: ● ●
Light bulb	: Not included
Connection	: Soft ceiling rose silicone / Power plug
Cable length	: 3 m CR (ceiling rose) / 5 m PP (power plug)
Material	: Recycled polypropylene

SIZING

ANDON is available in three sizes:

Small, Medium and Large.

S

Width
270 mm

Height
177 mm



M

Width
405 mm

Height
272 mm

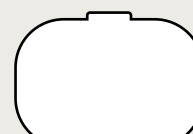

L

Width
540 mm

Height
354 mm

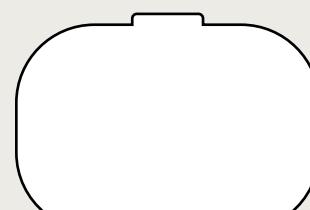

* The lamp holder is designed for glass LED light bulbs only and has been tested as compatible with the A60, ST64, G95 and G125 bulb shapes that guarantee rating of IP65 protection.

TORO

Introducing : distinguished by its circular design, drawing inspiration from Japanese lanterns. This fixture emits a comforting radiance, imparting a serene ambiance to your outdoor area.



BLOS™

Protection	: IP65*
Rated voltage	: 250 Vac
Class	: II
Lamp holder	: E27
Cable	: Outdoor UV textile cable
Cable colours	: ● ● ● ● ●
Shade colours	: ● ●
Light bulb	: Not included
Connection	: Soft ceiling rose silicone / Power plug
Cable length	: 3 m CR (ceiling rose) / 5 m PP (power plug)
Material	: Recycled polypropylene

SIZING

TORO is available in three sizes:

Small, Medium and Large.

S	Width	Height
	270 mm	252 mm



M	Width	Height
	405 mm	381 mm



L	Width	Height
	540 mm	503 mm



* The lamp holder is designed for glass LED light bulbs only and has been tested as compatible with the A60, ST64, G95 and G125 bulb shapes that guarantee rating of IP65 protection.



TP662-BI	95	TR618-BI	97	TR683-BI	97	TR771-BI	99	TR785-BI	99	BLOS	
TP662-BN	95	TR618-BN	97	TR683-BN	97	TR771-BN	99	TR785-BN	99	BL-AN-BL-L	125
TP662-BR	95	TR618-BR	97	TR683-BR	97	TR771-BR	99	TR785-BR	99	BL-AN-BL-M	125
TP662-BT	95	TR618-BT	97	TR683-BT	97	TR771-BT	99	TR785-BT	99	BL-AN-BL-S	125
TP662-CF	95	TR618-CF	97	TR683-CF	97	TR771-CF	99	TR785-CF	99	BL-AN-WH-L	125
TP662-CO	95	TR618-CO	97	TR683-CO	97	TR771-CO	99	TR785-CO	99	BL-AN-WH-M	125
TP662-NE	95	TR618-NE	97	TR683-NE	97	TR771-NE	99	TR785-NE	99	BL-AN-WH-S	125
TP662-OT	95	TR618-OT	97	TR683-OT	97	TR771-OT	99	TR785-OT	99	BL-SH-BL-L	124
TP662-RM	95	TR618-RM	97	TR683-RM	97	TR771-RM	99	TR785-RM	99	BL-SH-BL-M	124
TP662-TI	95	TR618-TI	97	TR683-TI	97	TR771-TI	99	TR785-TI	99	BL-SH-BL-S	124
TP663-BI	95	TR671-BI	97	TR685-BI	97	TR772-BI	99	TR788-BI	99	BL-SH-WH-L	124
TP663-BN	95	TR671-BN	97	TR685-BN	97	TR772-BN	99	TR788-BN	99	BL-SH-WH-M	124
TP663-BR	95	TR671-BR	97	TR685-BR	97	TR772-BR	99	TR788-BR	99	BL-SH-WH-S	124
TP663-BT	95	TR671-BT	97	TR685-BT	97	TR772-BT	99	TR788-BT	99	BL-TO-BL-L	126
TP663-CF	95	TR671-CF	97	TR685-CF	97	TR772-CF	99	TR788-CF	99	BL-TO-BL-M	126
TP663-CO	95	TR671-CO	97	TR685-CO	97	TR772-CO	99	TR788-CO	99	BL-TO-BL-S	126
TP663-NE	95	TR671-NE	97	TR685-NE	97	TR772-NE	99	TR788-NE	99	BL-TO-WH-L	126
TP663-OT	95	TR671-OT	97	TR685-OT	97	TR772-OT	99	TR788-OT	99	BL-TO-WH-M	126
TP663-RM	95	TR671-RM	97	TR685-RM	97	TR772-RM	99	TR788-RM	99	BL-TO-WH-S	126
TP663-TI	95	TR671-TI	97	TR685-TI	97	TR772-TI	99	TR788-TI	99		
TP665-BI	95	TR672-BI	97	TR688-BI	97	TR773-BI	99				
TP665-BN	95	TR672-BN	97	TR688-BN	97	TR773-BN	99	ART MAKER			
TP665-BR	95	TR672-BR	97	TR688-BR	97	TR773-BR	99	AM-DM100-CH	102		
TP665-BT	95	TR672-BT	97	TR688-BT	97	TR773-BT	99	AM-DM100-NR	102		
TP665-CF	95	TR672-CF	97	TR688-CF	97	TR773-CF	99	AM-DM140-CH	102		
TP665-CO	95	TR672-CO	97	TR688-CO	97	TR773-CO	99	AM-DM140-NR	102		
TP665-NE	95	TR672-NE	97	TR688-NE	97	TR773-NE	99	AM-DM200-CH	102		
TP665-OT	95	TR672-OT	97	TR688-OT	97	TR773-OT	99	AM-DM200-NR	102		
TP665-RM	95	TR672-RM	97	TR688-RM	97	TR773-RM	99	AM-FL120-CH	103		
TP665-TI	95	TR672-TI	97	TR688-TI	97	TR773-TI	99	AM-FL120-NR	103		
TP668-BI	95	TR673-BI	97	TR711-BI	99	TR775-BI	99	AM-FL140-CH	103		
TP668-BN	95	TR673-BN	97	TR711-BN	99	TR775-BN	99	AM-FL140-NR	103		
TP668-BR	95	TR673-BR	97	TR711-BR	99	TR775-BR	99	AM-FL200-CH	103		
TP668-BT	95	TR673-BT	97	TR711-BT	99	TR775-BT	99	AM-FL200-NR	103		
TP668-CF	95	TR673-CF	97	TR711-CF	99	TR775-CF	99	AM-MA40-CH	104		
TP668-CO	95	TR673-CO	97	TR711-CO	99	TR775-CO	99	AM-MA40-NR	104		
TP668-NE	95	TR673-NE	97	TR711-NE	99	TR775-NE	99	AM-MA60-CH	104		
TP668-OT	95	TR673-OT	97	TR711-OT	99	TR775-OT	99	AM-MA60-NR	104		
TP668-RM	95	TR673-RM	97	TR711-RM	99	TR775-RM	99	AM-ME40-CH	105		
TP668-TI	95	TR673-TI	97	TR711-TI	99	TR775-TI	99	AM-ME40-NR	105		
TR611-BI	97	TR675-BI	97	TR712-BI	99	TR778-BI	99	AM-ME60-CH	105		
TR611-BN	97	TR675-BN	97	TR712-BN	99	TR778-BN	99	AM-ME60-NR	105		
TR611-BR	97	TR675-BR	97	TR712-BR	99	TR778-BR	99	AM-MT20-CH	106		
TR611-BT	97	TR675-BT	97	TR712-BT	99	TR778-BT	99	AM-MT20-NR	106		
TR611-CF	97	TR675-CF	97	TR712-CF	99	TR778-CF	99	AM-MT21-CH	106		
TR611-CO	97	TR675-CO	97	TR712-CO	99	TR778-CO	99	AM-MT21-NR	106		
TR611-NE	97	TR675-NE	97	TR712-NE	99	TR778-NE	99				
TR611-OT	97	TR675-OT	97	TR712-OT	99	TR778-OT	99	THINK PAPER			
TR611-RM	97	TR675-RM	97	TR712-RM	99	TR778-RM	99	TP-BAZ-290	121		
TR611-TI	97	TR675-TI	97	TR712-TI	99	TR778-TI	99	TP-BAZ-440	121		
TR612-BI	97	TR678-BI	97	TR713-BI	99	TR781-BI	99	TP-BAZ-640	121		
TR612-BN	97	TR678-BN	97	TR713-BN	99	TR781-BN	99	TP-BIZ-210	119		
TR612-BR	97	TR678-BR	97	TR713-BR	99	TR781-BR	99	TP-BIZ-290	119		
TR612-BT	97	TR678-BT	97	TR713-BT	99	TR781-BT	99	TP-CLZ-290	115		
TR612-CF	97	TR678-CF	97	TR713-CF	99	TR781-CF	99	TP-CLZ-440	115		
TR612-CO	97	TR678-CO	97	TR713-CO	99	TR781-CO	99	TP-CLZ-640	115		
TR612-NE	97	TR678-NE	97	TR713-NE	99	TR781-NE	99	TP-DAZ-290	110		
TR612-OT	97	TR678-OT	97	TR713-OT	99	TR781-OT	99	TP-DAZ-440	110		
TR612-RM	97	TR678-RM	97	TR713-RM	99	TR781-RM	99	TP-DAZ-640	110		
TR612-TI	97	TR678-TI	97	TR713-TI	99	TR781-TI	99	TP-DAZ-890	110		
TR613-BI	97	TR681-BI	97	TR715-BI	99	TR782-BI	99	TP-GLZ-290	112		
TR613-BN	97	TR681-BN	97	TR715-BN	99	TR782-BN	99	TP-GLZ-440	112		
TR613-BR	97	TR681-BR	97	TR715-BR	99	TR782-BR	99	TP-GLZ-640	112		
TR613-BT	97	TR681-BT	97	TR715-BT	99	TR782-BT	99	TP-JAZ-440	117		
TR613-CF	97	TR681-CF	97	TR715-CF	99	TR782-CF	99	TP-JAZ-640	117		
TR613-CO	97	TR681-CO	97	TR715-CO	99	TR782-CO	99	TP-JAZ-890	117		
TR613-NE	97	TR681-NE	97	TR715-NE	99	TR782-NE	99	TP-LAZ-290	112		
TR613-OT	97	TR681-OT	97	TR715-OT	99	TR782-OT	99	TP-LAZ-440	112		
TR613-RM	97	TR681-RM	97	TR715-RM	99	TR782-RM	99	TP-LAZ-640	112		
TR613-TI	97	TR681-TI	97	TR715-TI	99	TR782-TI	99	TP-OVAL-440	114		
TR615-BI	97	TR682-BI	97	TR718-BI	99	TR783-BI	99	TP-OVAL-540	114		
TR615-BN	97	TR682-BN	97	TR718-BN	99	TR783-BN	99	TP-OVAL-640	114		
TR615-BR	97	TR682-BR	97	TR718-BR	99	TR783-BR	99	TP-S001-NPL	122		
TR615-BT	97	TR682-BT	97	TR718-BT	99	TR783-BT	99	TP-S002-NPL	122		
TR615-CF	97	TR682-CF	97	TR718-CF	99	TR783-CF	99	TP-S003-NPL	122		
TR615-CO	97	TR682-CO	97	TR718-CO	99	TR783-CO	99	TP-SKZ-210	118		
TR615-NE	97	TR682-NE	97	TR718-NE	99	TR783-NE	99	TP-SKZ-290	118		
TR615-OT	97	TR682-OT	97	TR718-OT	99	TR783-OT	99				
TR615-RM	97	TR682-RM	97	TR718-RM	99	TR783-RM	99				
TR615-TI	97	TR682-TI	97	TR718-TI	99	TR783-TI	99				

SEGULA

PERLUCI

AMARCÒRDS

Art Maker

think paper

BLOS™